

edge[®] DO



INSTRUCTION MANUAL

**Dear
Customer,**

Thank you for choosing a Hanna Instruments product.

Please read this instruction manual carefully before using the instrument.

This manual will provide you with the necessary information for correct use of the instrument, as well as a precise idea of its versatility.

If you need additional technical information, do not hesitate to e-mail us at tech@hannainst.com or view our worldwide contact list at www.hannainst.com.

All rights are reserved. Reproduction in whole or in part is prohibited without the written consent of the copyright owner, Hanna Instruments Inc., Woonsocket, Rhode Island, 02895, USA.

Included	4
Safety Measures	4
Description	5
Diagram	5
Product Diagram	5
Probe Diagram	7
Keypad Function	8
Guide to Indicators	9
Setup/Installation	10
Setting Up edge ^{® DO}	10
Electrode & Probe Connections	13
General Setup	14
Logging Function	16
Viewing Logged Data	18
PC & Storage Interface	21
Operational Guide	23
Dissolved Oxygen Setup	23
Dissolved Oxygen Probe Diagram	24
Dissolved Oxygen Meter Configuration	25
Dissolved Oxygen Calibration	26
Dissolved Oxygen Calibration Messages	28
Dissolved Oxygen GLP Information	28
Dissolved Oxygen Measurements	29
Maintenance	31
Dissolved Oxygen Probe Maintenance	31
Troubleshooting Guide	32
Specifications	33
Accessories	34

Remove the instrument from the packing material and examine it carefully to make sure that no damage has occurred during shipping. If there is any damage, please contact your local Hanna Instruments Office.

Each instrument **edge[®] DO (HI2004)** is supplied with:

- Bench cradle
- Wall cradle
- Electrode holder
- USB cable
- 5 VDC Power Adapter
- Instruction Manual
- Quality Certificate

HI764080: Digital polarographic dissolved oxygen probe with integrated temperature sensor

HI7041S: Electrolyte for DO probe

2 DO membrane caps for **HI764080** DO probe

2 replacement O-Rings for membrane caps

Electrode protective cap

Note: Save all packing material until you are sure that the instrument works correctly. Any defective item must be returned in its original packing.

Before using this product, make sure that it is entirely suitable for your specific application and for the environment in which it is used.

Operation of this instrument may cause interference to other electronic equipment, requiring the operator to take steps to correct interference. Any variation introduced by the user to the supplied equipment may degrade the instrument's EMC performance.

To avoid damages or burns, do not put the instrument in microwave ovens. For your and the instrument's safety, do not use or store the instrument in hazardous environments.

edge[®] DO enables the user to make fast, accurate measurements of dissolved oxygen using one of the Hanna Instruments edge[®] DO digital sensors for Dissolved Oxygen. Each digital sensor has a unique serial number that is automatically identified by the meter. Once connected to the meter, the sensor is ready to measure dissolved oxygen along with temperature.

The user interface permits you to adapt edge[®] DO to your exact measurement requirements. The intuitive design simplifies configuration, calibration, measurement, data logging and transfer of data to a USB thumb drive or computer. (Every feature and measurement detail is designed to give you an edge in measurement technology.)

edge[®] DO is versatile in many ways. The slim meter and probe can be used as a portable device (using its rechargeable battery) or used in its bench or wall cradles (that also power the meter) as a line-powered laboratory instrument.

PRODUCT DIAGRAM

- Sleek, clean, intuitive design
- Internal clock and date
- Auto parameter recognition
- Dedicated GLP key
- GLP data included with logged data
- Simplified data transfer to a PC
- Up to 8 hour battery life when used as a portable device

Side & Back view

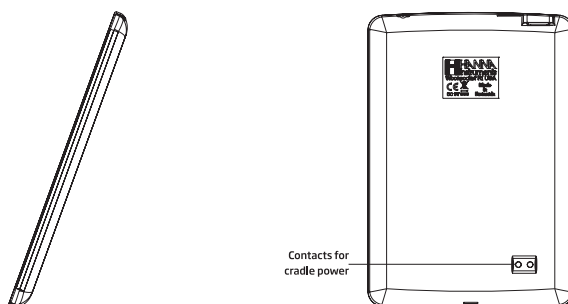

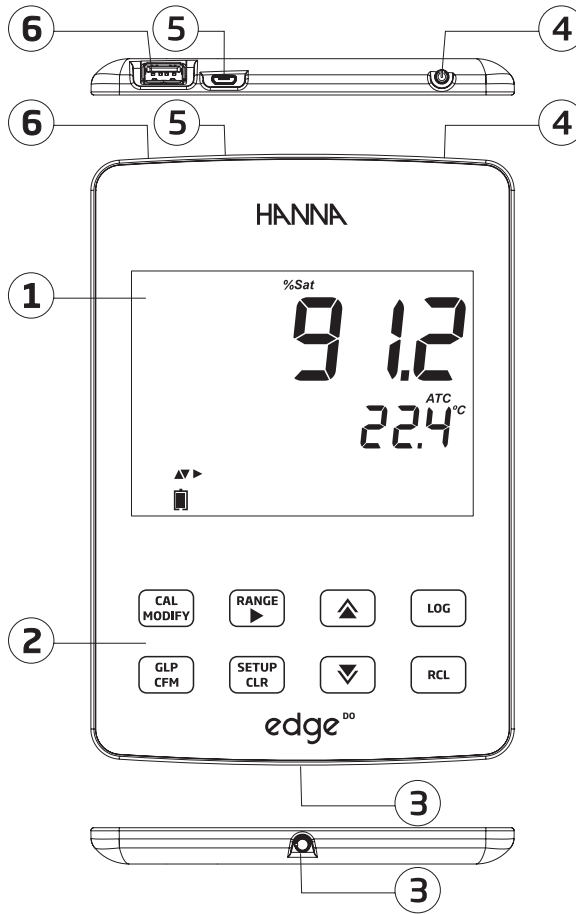

- | | |
|---|--|
| <ul style="list-style-type: none"> 1. Liquid Crystal Display (LCD) 2. Capacitive Touch Keypad 3. 3 mm jack input for edge^{DO} digital probes 4. Top mounted ON/OFF button | <ul style="list-style-type: none"> 5. Micro USB device connection for power or PC interface 6. Standard USB host connection for data transfer to a USB thumb-drive |
|---|--|

PROBE DIAGRAM



DO Electrode

- Probes process signal directly for noise free measurements
- Auto sensor recognition
- Store calibration specific data from the last calibration
- Are built with materials suitable for use in chemical analysis
- Have integrated temperature measurement
- Incorporate a 3 mm jack termination
- Unique serial ID in every probe for traceability

KEYPAD FUNCTION

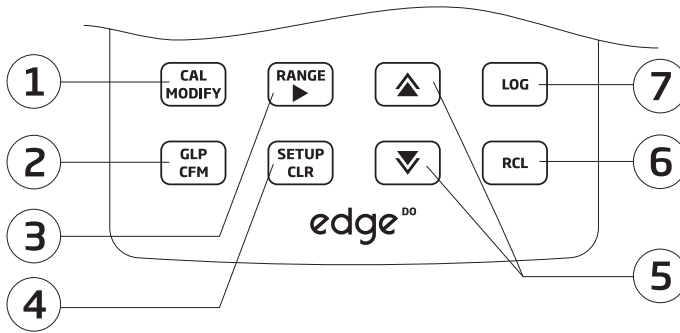

1. **CAL/MODIFY** - Used to enter and exit calibration mode. In SETUP, used to initiate changes of a configuration setting.
2. **GLP/CFM** - Used to display GLP calibration information. In SETUP, used to confirm change made. In calibration, used to accept calibration points.
3. **RANGE/▶** - Used to select measurement range. In SETUP, used to move to right in pick list. In log RCL, used to view GLP data for a data point.
4. **SETUP/CLR** - Used to enter/exit SETUP mode. During calibration, used to clear previous calibration data. In log RCL, used to clear log records.
5. **▼/▲** - Used to scroll through SETUP menu. Used to change selection when modifying a parameter in SETUP.
6. **RCL (Recall)** - Used to view logged records or view % log memory used.
7. **LOG** - Used to log data by manual log on demand or manual log on stability or to start/stop interval logging.

*Note: You can increase/decrease the speed to change the value of a parameter. Proceed as follows:
Press and hold down the ▲ or ▼ key, then slide the finger toward the double apex to increase the speed that a value changes.*



GUIDE TO INDICATORS

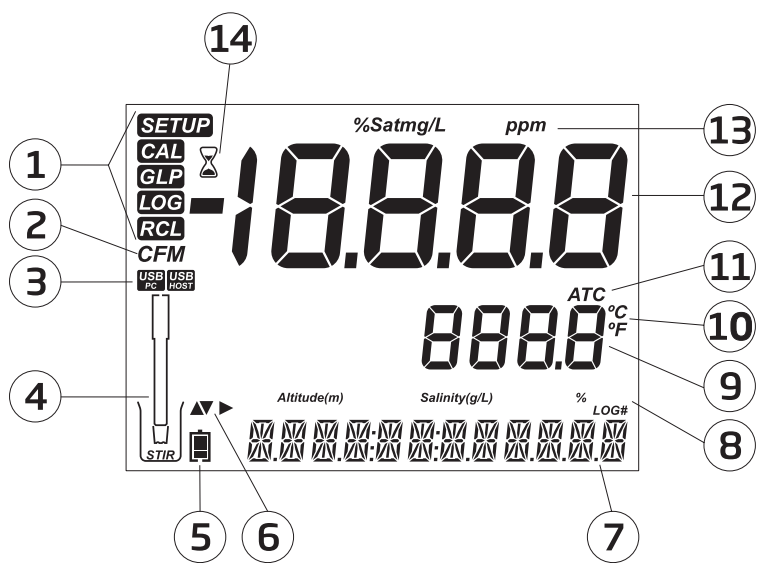

- | | |
|--|---|
| 1. Mode tags | 8. Labels |
| 2. Confirm tag | 9. Second LCD line, temperature measurement |
| 3. USB connection status | 10. Temperature units |
| 4. Probes symbol | 11. Temp. Compensation status |
| 5. Battery symbol | 12. Measurement line |
| 6. Arrow tags, displayed when they are available | 13. Measurement units |
| 7. Third LCD line, message area | 14. Stability Indicator |

The third line of the LCD (7) is a dedicated message line. During measurement the user may use the \blacktriangle \blacktriangledown keys to select desired message. Options include date, time, calibration data, battery charge or no message. If a measurement error or log status change occurs during measurement, the third line will display a pertinent message.

SETTING UP edge® D0

The main operating modes of edge® D0 are setup, calibration, measurement, data logging, and data export. Follow this general outline of steps to get you started. The following topics are expanded upon in the sections that follow in this manual.

1. Familiarize yourself with the design features of this unique meter.
2. Decide how the meter will be used and set up the wall or bench cradle in a clean area near line power.
3. Turn edge® D0 on using the ON/OFF button located on the top of the meter.
4. Plug in the probe required for measurement.
5. SETUP the measurement parameters required for the measurement you will be making.
6. Calibrate the sensor/probe.

You are now ready for measurements.

Bench Cradle Setup

Insert electrode holder arm into the post on the pivoting base.

Connect the probe connector to the socket located at the bottom of the instrument.

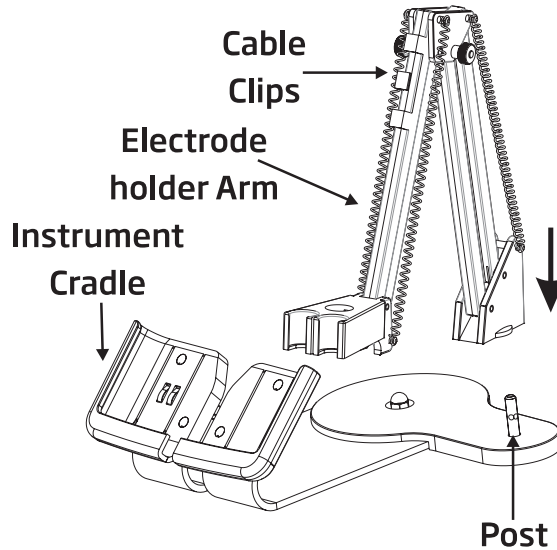

Slide **edge® D0** into the cradle while positioning the probe cable behind the cradle. Put the probe/sensor into the electrode holder and secure cable in clips.

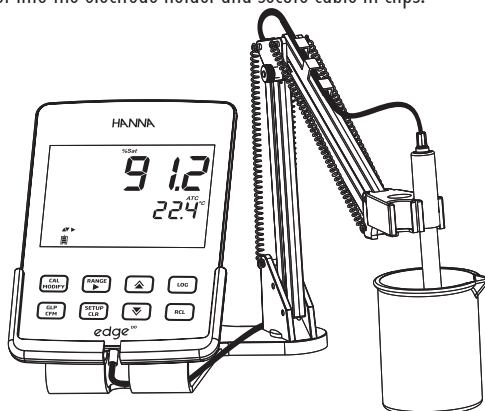

Connect the power adapter cable to the rear socket of the bench cradle. Connect the other end to the power adapter and plug into line power. Verify the battery icon indicates charging.

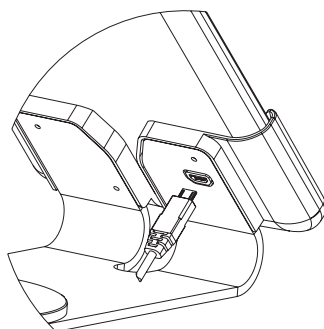

Wall Cradle Setup

Choose suitable wall location. (Use 2.5 mm or US #3 bit). Fasten the wall cradle using the provided screws. Snap cover over screw heads.

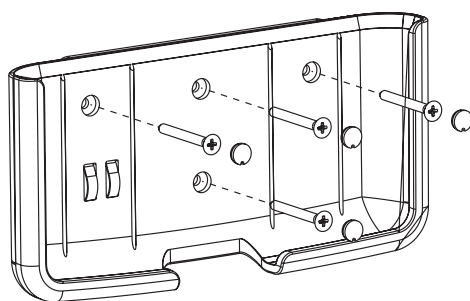

Connect the power adapter cable to the bottom socket of the wall cradle. Connect the other end to the power adapter and plug into line power.

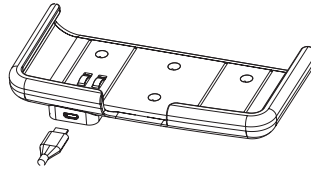

Connect the 3 mm probe jack to the socket located at the bottom of **edge® D0**. Slide **edge® D0** into the wall cradle. Verify the battery icon indicates charging.

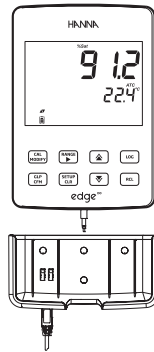

Power Connection

Alternatively to using the cradle for power, **edge® D0** can be powered by micro USB socket at the top. Plug the 5 VDC adapter into the power supply socket or by connecting directly to a PC.

Note: edge® D0 is supplied with a rechargeable battery inside, which provides about 8 hours of continuous use. Whenever edge® D0 is connected to the power adapter or to a PC, the battery is charging.

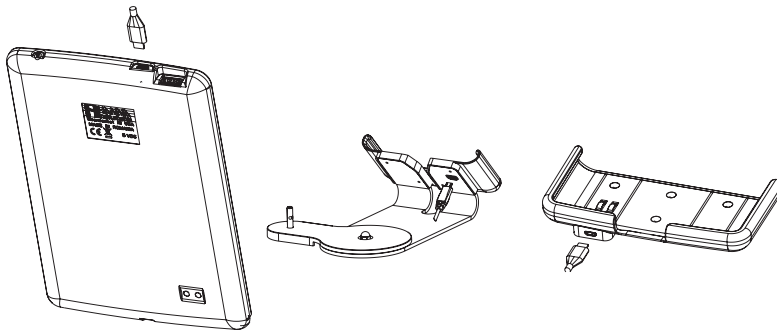

ELECTRODE & PROBE CONNECTIONS

Connect the 3 mm probe jack to the probe input located on the bottom of **edge**[®] **00**. Make sure the probe is completely connected. If the probe is recognized, "CONNECTING" message is displayed along with sensor model.

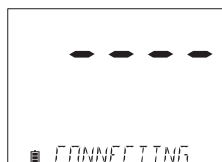

If the probe is not connected or not recognized, "NO PROBE" message is displayed.

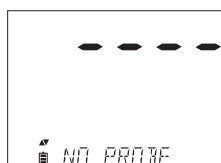

GENERAL SETUP

The following General Setup options are displayed regardless of the sensor being used. These settings remain when switching to another probe type or when no probe is attached. Options are tabulated in the table below with choices and default values. Options are accessed by pressing **SETUP/CLR** key. Loop through the options by using the **▲ ▼** keys. To modify a setting, press **CAL/MODIFY** key. The option may be modified by using **RANGE/▶, ▲** and **▼** keys. Press **GLP/CFM** key to confirm the change. To exit SETUP press **SETUP/CLR** key.

Option	Description	Choices	Default
*Only seen when cable connection between micro USB and PC is made.	Select if PC is being used for charging battery (and meter will be used for logging) or if Data will be exported to the PC.	LOG ON EDGE or EXPORT TO PC	LOG ON EDGE
Log	Select log type to be used from 3 types of logging: Manual log on demand Manual log on stability (3 types of stability criteria available) Timed interval lot logging	Manual Log Stability Log: Fast, Medium, Accurate; Interval Log: Seconds: 5,10, 30; Interval Log Minutes: 1, 2, 5, 15, 30, 60, 120, 180.	Interval (5 Sec)
Set Calibration Expiration Warning	Meter will indicate "CAL DUE" when set time in this parameter has been exceeded.	1, 2, 3, 4, 5, 6, 7 days or OFF	7 days
Probe Specific	Parameters that are specific to a measurement type are inserted here in the SETUP list.		
Set Date	Press CAL/MODIFY key to Set current date, displayed in ISO format. Press GLP/CFM key to save changes.	YYYY/MM/DD Date	Set date
Set Time	Press CAL/MODIFY key to Set current time, displayed in ISO format. Press GLP/CFM key to save changes.	24hr:MM:SS Time	Set time

Option	Description	Choices	Default
Set Auto Off	Used to save battery life by automatically turning off when no key press is detected for time set and meter is not in active logging or calibration mode.	5, 10, 30, 60 Min or Off	10 MIN
Sound	If enabled, a short audible tone is produced for key stroke or calibration confirmation and a longer tone for wrong key.	On or Off	On
Temperature Unit	Select degree Celsius or Fahrenheit scale for displayed and logged temperatures.	°C or °F	°C
LCD Contrast	Permits modification of the display contrast for various lighting conditions.	1 to 8	3
Flash Format* Only seen when log errors are present.	Permits formatting the flash drive.	On or Off	OFF
Message Transition	User may choose how messages are displayed on third LCD line of display.	Word scroll messages or letter scroll messages	Letter scroll messages
Reset Config To Default	Press the CAL/MODIFY key and GLP/CFM key (when prompted) to reset parameters.		
Instrument Firmware/ Probe Firmware	Displays firmware version of meter. Using the RANGE/▶ key switches to Probe firmware (if connected) and diagnostic made for troubleshooting.	View only	Current firmware version.
Meter ID/ Meter SN/ Probe SN	User ID and Serial Number of meter and probe (if connected). Use RANGE/▶ key to change between the three parameters.	Meter ID is user selectable	0000/ Serial Number

Note: Options that are seen under special conditions only.

LOGGING FUNCTION

Note: If powering edge[®] D0 through the micro USB connector to a PC, a SETUP option will require the choice "LOG ON EDGE" or "EXPORT TO PC".

1000 log records can be stored into edge[®] D0 memory. This memory is shared between and all logging types (Manual, Manual Stability, Interval logs).

The maximum number of records for an Interval lot is 600 records (provided log space is available).

A record is a stored reading and a lot is a group of records.

Types of Logging

Interval logging: A continuous log recorded using a user-selected timed period. (This is not available in Basic mode).

Manual log on demand: Readings are logged each time **LOG** key is pressed. All of the records are stored in a single Manual lot for the measurement type. New records made on different days are stored in the same Manual lot.

Manual Stability log on demand: A log on demand that is made each time **LOG** key is pressed and the stability criteria is reached. Stability criteria may be set to Fast, Medium or Accurate settings.

In Setup mode, choose log parameter, press **CAL/MODIFY** key then use the **RANGE/▶** key to select between Interval, Manual, or Stability. When Interval is displayed, use the **▲** and **▼** keys to select the setting for the timed interval. When Stability is displayed, use the **▲** and **▼** to select the measurement stability setting.

A complete set of GLP information including date, time, range selection, temperature reading, calibration information and probe serial number is stored with each log made.

Interval Logging

Select Interval and sampling period in the SETUP menu. To start Interval logging, press the **LOG** key while the instrument is in measurement mode.

A "PLEASE WAIT" message will be displayed followed by the number of free spaces. During active interval logging, lot information is displayed on the third LCD line. The line indicates in which lot the data will be placed and keeps track of the number of logged records taken. The "LOG" tag is continuously on during active logging.

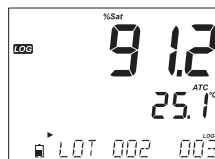

Pressing **RANGE/▶** key during an interval log will display the number of logs available.



Pressing the **LOG** key again will stop the Interval logging session. The "LOG STOPPED" message will be displayed for a few seconds. If a sensor failure occurs during interval logging, the message "OUT OF SPEC." will alternate with logging information.

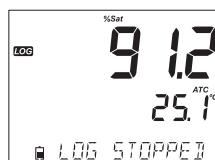

Manual Logging

Select Manual in the SETUP menu. To initiate a Manual log, press the **LOG** key while the instrument is in measurement mode. The "PLEASE WAIT" screen will be displayed briefly followed by a screen indicating the measurement has been saved and then a screen indicating the log record number.

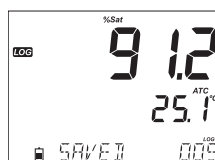

The "LOG" tag will be displayed on all 3 screens.

"PLEASE WAIT"

"SAVED" with the log record number

"FREE" with the number of free spaces available



Stability Logging

Select Stability and choose measurement stability criteria in the SETUP menu. To initiate the Stability log, press the LOG key while the instrument is in measurement.

The "PLEASE WAIT" screen will be displayed briefly followed by a screen showing the stability tag, "LOG" tag and a "WAITING" message. The log can be stopped while the "WAITING" message is displayed by pressing LOG key again.



When the stability selected criteria has been met, a "SAVED" message will be displayed followed by a screen indicating how much log space is available. The "LOG" tag will be displayed on all 4 screens.



"PLEASE WAIT"

"WAITING"

"SAVED" with the log record number

"FREE" with the number of free spaces available

VIEWING LOGGED DATA

All log records stored on edge® D0 may be viewed on the meter by pressing the RCL key.

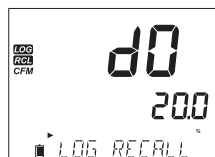

Use the ▲ ▼ keys to choose the type of logging records to view.

Choices are:

- Manual log on demand lot,
- Manual log on stability lot,
- Individual Interval logging lots.

If no data was logged for the selected measurement range, the instrument displays the following messages:

- “NO MANUAL LOGS”
- “NO STABILITY LOGS”

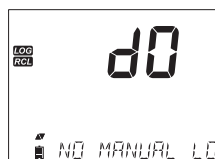

Press **GLP/CFM** key to enter inside lot information to view recorded data. Use the **▲▼** keys to toggle between different records.

Use **RANGE/▶** to display GLP data including calibration information, date, time, etc.

Press **SETUP/CLR** key then **GLP/CFM** key when deleting records or lots.

Press **RCL** key to exit the logging type.

Press **RCL** key to return to the measurement screen.

Delete Logging Type/Lot

Press **RCL** followed by **GLP/CFM** key.

Use the **▲▼** keys to select the Manual/Stability records or Interval lots to delete.

Press **SETUP/CLR** key. The instrument will display “CLEAR MANUAL” for Manual Records, “CLEAR STAB” for Stability Records.

For Interval lots, the message “CLEAR”, followed by the selected lot will be displayed with “CFM” tag blinking.



Press the **▲▼** keys to select a different lot. Press **GLP/CFM** key. The instrument will display “PLEASE WAIT”.

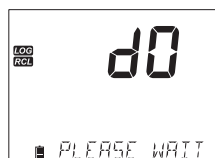

“CLEAR DONE” is displayed for a few seconds after the selected Interval lot is deleted.

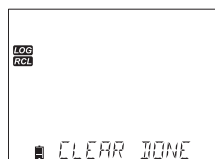

Delete Records (Manual and Stability log on demand)

To delete individual records (Manual and Stability logs only), enter

Manual (Stability) log by pressing **GLP/CFM** key when Manual (Stability) is displayed.

Use the **▲▼** keys to select the record to be deleted and then press **SETUP/CLR** key.

The instrument will display “CLEAR REC.” and record number along with “CFM” tag blinking. Use the **▲▼** keys to select another record if necessary.



Press **GLP/CFM** key. The instrument will display "PLEASE WAIT" and then "CLEAR DONE" message. When individual logs are deleted within saved MANUAL or STABILITY logs, the logs will renumber, filling in the deleted data but staying in chronological order.

To delete all records of the MANUAL (STABILITY) log, proceed as described on page 19 for LOTS.

Select the Manual (Stability) lot and press **SETUP/CLR** key. The "CLEAR" message will be displayed along with "MANUAL" or "STABILITY" and CFM tag blinking on the LCD. Press the **GLP/CFM** key to confirm the deleting of the selected lot (MANUAL or STABILITY) or all records. Press **SETUP/CLR** key to exit without deleting.



The lot number is used to identify particular sets of data. The lot numbers are allocated successively until 100, even if some lots were deleted. The total number of lots that can be saved is 100. If some are deleted (for example 1-50), fifty additional logs may be stored. These will be numbered 101-150. The lots are allocated successively (provided available memory space) until 999 is reached. After this, it is necessary to delete all the LOT logs to start over the numbering.

Delete All

All logs, may be deleted in a single clear. This function will delete all MANUAL, STABILITY and INTERVAL logs.

Press the **RCL** key. The DO type will be blinking. Use **RANGE/▶** key to select desired measurement parameter log data to delete.



While the measurement type is blinking and message states "LOG RECALL", press **SETUP/CLR** key.

"CLEAR ALL" and measurement type will be displayed with "CFM" tag blinking. Press **GLP/CFM** key.



"PLEASE WAIT" and the percent cleared will be displayed until completed. The procedure can be repeated for the other measurement modes.

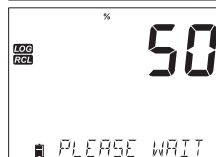

Note: If SETUP/CLR key is pressed in error, press SETUP/CLR key again to exit without deleting.



PC & STORAGE INTERFACE

Logged data on **edge[®] D0** can be transferred from the meter to a USB flash drive by using the log recall function. The minimum requirement for the drive is USB 2.0. Select the DO record you wish to export and follow the simple steps below.

Connect USB flash drive to the USB port, located on the top of the meter. Press the **RCL** key. Select Manual, Stability, or interval lots by using the **▲▼** keys. Press the **LOG** key (not **GLP/CFM**). The “USB HOST” tag should come on.



“PLEASE WAIT” message appears followed by “EXPORT”. Press **GLP/CFM** key to export the selected record or lot. If **GLP/CFM** key is not pressed in 10 seconds, the USB host will become inactive.



The meter will display the percentage of export.

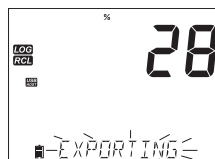

The export percentage should go to 100%. Remove USB flash drive.

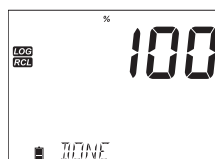

If the selected file is already saved on the flash drive, **edge[®] D0** will ask for confirmation of overwriting the existing file. The message “OVERWRITE” and “CFM” tag will blink. Press **GLP/CFM** key for overwriting the existing file or **CAL/MODIFY** key to exit without exporting.



After exporting the display will return to the selected file. Press the **RCL** key twice to return to measurements.



Note: Do not remove USB flash drive during an active export transfer.

Logged data on the **edge[®] D0** can be transferred from the meter to a PC by following these simple directions. Suitable operating systems include Windows (XP minimum), OS X or Linux.

1. Connect **edge[®] D0** to the PC using the supplied micro USB cable.
2. Turn on **edge[®] D0**.
3. Press **SETUP/CLR** key and select "LOG ON EDGE".
4. Press **CAL/MODIFY** key then use **▲▼** keys to change to "EXPORT TO USB".
5. Press **GLP/CFM** key and the USB/PC Tag is displayed.
6. Press **SETUP/CLR** key to exit.

The PC should detect the USB as a removable drive. Open the drive to view the stored files. Log files are formatted as Comma separated values (*.CSV) and can be opened with any text editor or spreadsheet program.

Note: Western Europe (ISO-8859-1) character set and English language are suggested settings. Other files may be visible depending upon computer settings. All files stored will appear in this folder.

Adjust Font or column width appropriately.

Interval logs are designated as DO Lots. ie. DOLOT001, DOLOT002, DOLOT003.

The Manual Lots are DOLOTMAN.

The Stability Lots are DOLOTSTAB. All stability logs, regardless of stability setting, are located in the same stability file for that measurement.

Click on the desired log to view data.

Note: If "°C !" appeared in log data, the electrode/probe was used beyond it's operation specifications and the data is not considered reliable. If "°C !!" appeared in log data, the temperature sensor within the probe or electrode is broken and the device should be replaced. Logged data should not be considered reliable.

DISSOLVED OXYGEN SETUP

Steps To Optimize

1. Determine if Concentration or % Saturated measurements will be made.
2. Prepare the Dissolved Oxygen (DO) probe for measurement.
3. Connect the probe to the meter and configure the SETUP parameters.
4. Calibrate the DO sensor.
5. Take measurements using the DO sensor.

Measurements Available

Concentration measurements in water and % oxygen-saturated measurements are available using **edge[®] DO** together with **HI764080** DO probe. Algorithms used for concentration measurements (units of ppm or mg/L) are based upon the oxygen solubility in air-saturated fresh water. Compensation for salinity and altitude are made by configuring SETUP options. Percent saturation measurements are based upon the partial pressure of oxygen and are suitable for measurement in samples other than air-saturated fresh water. It is advised to check material compatibility of the probe with the sample.

DO Probe Preparation

CAUTION: Use care during servicing and use. The **HI764080** contains a glass insulator. Do not drop or handle carelessly.

Probes from Hanna Instruments are shipped dry.

1. Carefully remove the cardboard shipping tube used to protect the probe during shipping. Save the tube, should the probe be stored dry again.
2. Open membrane package and remove one O-Ring and one membrane cap.
3. Rinse the membrane cap with a small amount of **HI7041** electrolyte and discard.
4. Position O-Ring in cap as indicated. Refill membrane cap $\frac{3}{4}$ full with electrolyte solution, ensure to cover the O-Ring.
5. Holding the membrane cap by the top, tap the side walls of the membrane cap to dislodge gas bubbles and force them to rise to the surface. Do not tap on the membrane directly as it may damage it.
6. With the probe facing down, slowly screw the cap counterclockwise until completely tightened. Electrolyte will overflow.
7. Rinse outer body of the probe and inspect membrane for entrapped gas bubbles. The cathode area should be free of bubbles.
8. Connect the DO probe to **edge[®] DO** meter and turn meter on.
9. Allow probe conditioning (polarizing) function to occur.

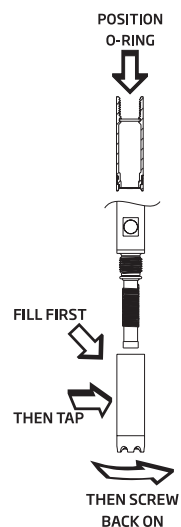

During this process, the following message will be displayed on the LCD, "DISSOLVED OXYGEN PROBE CONDITIONING".

The conditioning message will be displayed for about 60 seconds while the DO probe is conditioned. If the probe was conditioned and a new conditioning is not necessary, press any key to enter measurement mode.



The probe is polarized with a fixed voltage of approximately 800 mV between the cathode and anode. Probe polarization is essential for stable measurements. With the probe properly polarized, oxygen is continually consumed as it passes through gas permeable PTFE membrane.

If polarization is interrupted, the electrolyte solution continues to be enriched with oxygen until it reaches an equilibrium with the surrounding solution. Whenever measurements are taken with a non-polarized probe, the measurement will be drifty and inaccurate. The measurement will jump when the probe is moved.

Note: When not in use and during polarization, use the protective transparent cap.

DISSOLVED OXYGEN PROBE DIAGRAM

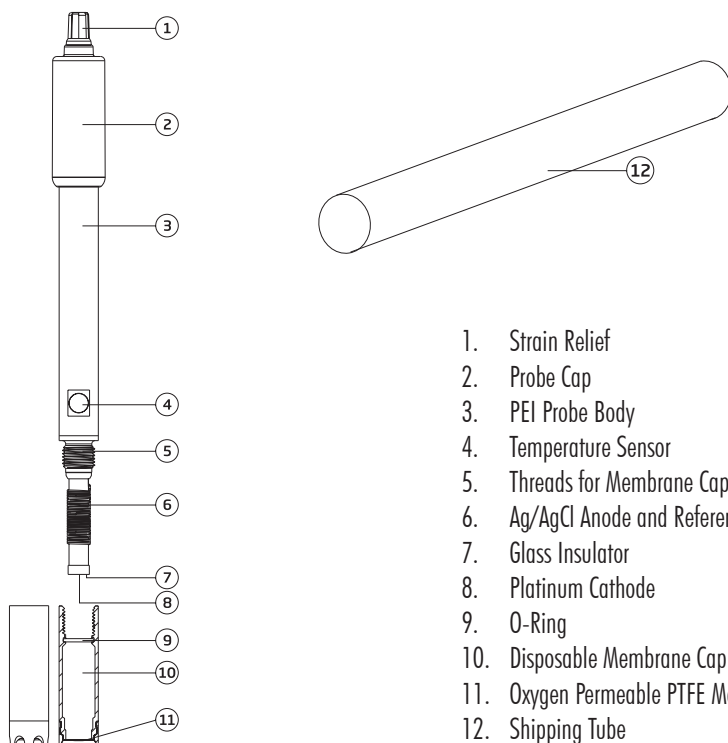

- 1. Strain Relief
- 2. Probe Cap
- 3. PEI Probe Body
- 4. Temperature Sensor
- 5. Threads for Membrane Cap
- 6. Ag/AgCl Anode and Reference
- 7. Glass Insulator
- 8. Platinum Cathode
- 9. O-Ring
- 10. Disposable Membrane Cap
- 11. Oxygen Permeable PTFE Membrane
- 12. Shipping Tube

DISSOLVED OXYGEN METER CONFIGURATION

DO (Dissolved Oxygen) meter operation is configured using the SETUP key with a DO probe connected to the meter. The parameter-specific options will be seen inserted into the menu.

Parameter	Description	Choices	Default
Altitude (m)	Concentration measurements of dissolved oxygen change depending on atmospheric pressure. A convenient way to estimate atmospheric pressure effects is by the related parameter of elevation (m) above or below sea level. Enter altitude in meters closest to the actual altitude to ensure the most accurate calibration and concentration measurement.	-500, -400, -300, -200, -100, 0, 100, 200, 300, 400, 500, 600, 700, 800, 900, 1000, 1100, 1200, 1300, 1400, 1500, 1600, 1700, 1800, 1900, 2000, 2100, 2200, 2300, 2400, 2500, 2600, 2700, 2800, 2900, 3000, 3100, 3200, 3300, 3400, 3500, 3600, 3700, 3800, 3900, 4000 m	0
Salinity (g/L)	Dissolved oxygen solubility decreases if water contains salts. Selecting this factor as to be close to your known salt level, will improve the accuracy of DO concentration calibration and measurement.	0, 1, 2, 3, 4, 5, 6, 7, 8, 9, 10, 11, 12, 13, 14, 15, 16, 17, 18, 19, 20, 21, 22, 23, 24, 25, 26, 27, 28, 29, 30, 31, 32, 33, 34, 35, 36, 37, 38, 39, 40 g/L	0
DO Units	Select preferred measurement units for DO concentration.	mg/L or ppm	ppm

Salinity and Altitude Compensation

Temperature, altitude and salinity compensation are used for DO concentration measurements (ppm or mg/L). When the water is colder, it can hold more dissolved oxygen, when it is warmer it holds less oxygen. Compensation for temperature-related solubility is done automatically using the built-in temperature sensor within the DO probe and algorithms in *edge*[®] *DO*. When water is measured at an altitude below sea level, oxygen solubility increases, but above sea level the oxygen solubility decreases. To compensate for this during calibration and measurement, the user must provide the approximate altitude (in meters) in the SETUP menu. The settings are in 100 m increments; select the value closest to the actual altitude. Some examples of altitudes around the world follow:

Location	Meter	Feet
Sebkha paki Tah, Morocco	-55	-180
Lake Frome, Australia	-6	-20
Netherlands, coastal providence	-1 to -7	-3 to -23
Lake Michigan, USA	176	577
Lake Geneva; France, Switzerland	372	1220
Denver, CO USA	1609	5279
Mount Everest	8848	29029

The solubility of oxygen in water is also influenced by the amount of salt the water contains. Seawater typically has a salinity of 35 g/L and the oxygen solubility is 18 % less compared to fresh water at 25 °C. By entering the approximate salinity value, the calibration and subsequent concentration measurement will be compensated to display the correct oxygen concentration. A 18 % error would result if the salinity value is not entered.

Note: Salinity and Altitude have no effect on % oxygen solubility range.

When water is fresh (no sea water), the concentration of oxygen will be at a maximum. The solubility of the oxygen dissolved in water is decreased when water is brackish or seawater. The solubility of oxygen in water is decreased when measurements are made at elevations above sea level.

DISSOLVED OXYGEN CALIBRATION

Before proceeding with the calibration, make sure the probe is ready for measurements (see page 23), i.e. the membrane cap is filled with electrolyte, the probe is connected to the meter and properly polarized. For an accurate calibration, it is recommended to wait at least 15 minutes to ensure conditioning of the probe. Keep the protective cap on during polarization time and remove it for calibration and measurements. Follow the calibration procedure.

Calibrate the probe frequently, especially if high accuracy is required. The probe can be calibrated at 2 points: 100.0 % (slope calibration) and 0.0 % (zero calibration).

Initial Preparation

Prepare a fresh bottle of **HI7040** by following package directions. Use solution within one month of preparation. Pour small quantities of **HI7040** Zero Oxygen solution into a beaker. If used, remove the protective cap from the DO probe.

100% Saturated Calibration

It is suggested to perform the slope calibration in water-saturated air.

Pour water into a small beaker.

Rinse the polarized probe with clean water.

Dry the probe tip and allow a few seconds for the LCD reading to stabilize (probe in air).

Suspend probe with membrane just over the beaker of water. Press **CAL/MODIFY** key.

The “” tag will be displayed along with “WAIT” blinking on the LCD until the reading is stable.

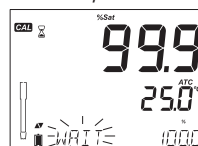

When the reading is stable and is within the limits, “CFM” tag starts blinking. Press **GLP/CFM** key to confirm the 100.0 % DO calibration.

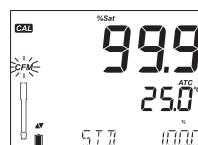

Press **CAL/MODIFY** key to leave calibration after the first point. The instrument will display “SAVING” message and it will return to measurement mode memorizing the slope calibration data.

Zero Calibration

Press **CAL/MODIFY** key or continue with calibration after confirming the first point. The meter will display “WAIT” and “0.0 %” will be displayed in lower right corner. Submerge the probe membrane and temperature sensor into the beaker containing **HI7040** Zero Oxygen solution and stir gently for 2-3 minutes, the reading will go down.

When the reading is stable and stops decreasing, “CFM” tag starts blinking. Press **GLP/CFM** key to confirm the 0.0 % DO calibration.

The instrument will display “SAVING” message and it will return to measurement mode. Rinse probe tip off in water before taking measurements in samples.

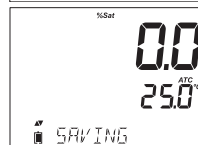
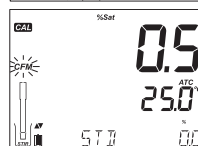
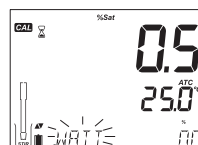

DISSOLVED OXYGEN CALIBRATION MESSAGES

If the reading is outside limits, “WRONG STANDARD” message will be displayed.

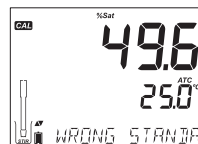

If the temperature is out of range (0.0 - 50.0 °C) during calibration, then the message “WRONG STANDARD TEMPERATURE” will be displayed and temperature value will blink.

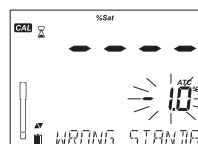

DISSOLVED OXYGEN GLP INFORMATION

GLP refers to a quality control function used to ensure uniformity of probe calibrations and measurements. The dedicated **GLP/CFM** key opens a file of the latest calibration information. Use the **▲▼** keys to scroll the stored information. This includes the standards used, temperature of the standard, Altitude and Salinity factors, time and date of the last calibration, the expired calibration information and the probe serial number. This information is also included with all logged data.

Last DO Calibration Data

The last DO calibration data is stored automatically after a successful calibration. To view the DO calibration data, press **GLP/CFM** key when the instrument is in measurement mode.



The instrument will display:

The calibration standard and the calibration temperature:



0.0 % will be displayed if the instrument was calibrated at this point.
100.0 % calibration point, if instrument was calibrated in water-saturated air.

The altitude and salinity setting at the moment of calibration together with the current reading.

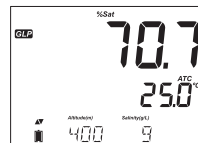

The time of day that the calibration was performed together with the current reading.



The date of the calibration together with the current reading.

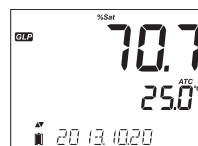

Calibration Expiration status together with the current reading: If disabled, "EXPIRATION WARNING" is displayed.

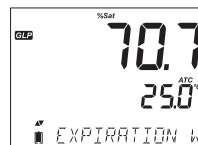

If enabled, the number of days until the calibration alarm "CAL DUE" will be displayed. (i.e. "CAL EXPIRES IN 2 DAYS")

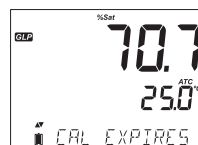

If enabled, the number of days the calibration has expired (i.e. "CAL EXPIRED 2 DAYS AGO").

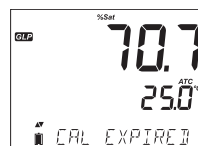

The probe serial number together with the current reading.

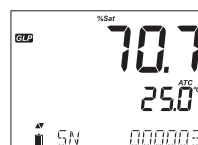

DISSOLVED OXYGEN MEASUREMENTS

Make sure that the probe is polarized, calibrated and the protective cap has been removed.

Rinse probe.

Submerge the probe in the sample to be tested, make sure the temperature probe is also immersed.

Allow time for the reading to stabilize.

Note: The sample should be stirred when taking a reading.

The Dissolved Oxygen value (in %) is displayed on the first LCD line and the temperature on the secondary LCD line.



Press **RANGE/▶** key to change the reading from % to ppm (mg/L) and vice versa.

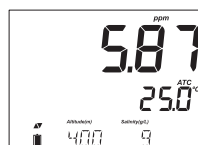

Oxygen is consumed during the measurement. For accurate DO measurements, water movement of 0.3 m/s is suggested. This is to ensure that the oxygen-depleted membrane surface is constantly measuring a representative sample. It is recommended to use magnetic stirrers. The probe has a built-in temperature sensor. Make sure it is also immersed in sample. The measured temperature is indicated on the second LCD line as shown on page 27. Allow time for the probe to reach a thermal equilibrium before taking any measurement. This can take several minutes. If the difference between the temperature at which the probe was stored and the sample's temperature is greater, the time will be longer.

If the DO temperature exceeds the limits of the probe, the message "PROBE OUT OF SPEC" will scroll on the third LCD line and LCD will display dashes. If the temperature exceeds the probe specification 50 °C, then "50 °C" will blink on the display. If interval logging, the message "OUT OF SPEC." will alternate with the Log specific messages in both of these cases. The Log file will indicate "°C!" next to the data.

If the temperature sensor is damaged, "BROKEN TEMPERATURE SENSOR" will be displayed and the temperature will display "----" along with the unit tag blinking on the second LCD line. The Log file will indicate "°C!" next to the data.

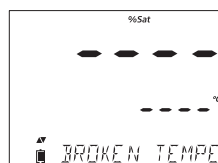

DISSOLVED OXYGEN PROBE MAINTENANCE

The DO probe body is made of PEI.

Use the protective cap when the probe is not in use. To replace the membrane or refill with electrolyte, proceed as follows:

For a new probe, remove the protective shipping tube by gently twisting and pulling it off the body of the probe (see fig. 1).

If the membrane was previously installed, unscrew the membrane cap by turning it clockwise (see fig. 2).

The new membrane cap should be rinsed with electrolyte solution. Refill with clean electrolyte solution.

Gently tap the sides of the membrane cap to ensure that no air bubbles remain trapped. Do not tap the bottom directly with your finger, as this will damage the membrane.

Make sure that the rubber O-Ring sits properly inside the membrane cap. With the sensor facing down, slowly screw the membrane cap counterclockwise. Some electrolyte will overflow.

The platinum cathode (DO Probe Diagram, page 24) should always be bright and untarnished. If it is tarnished or stained, the cathode should be cleaned. You can use a clean lint-free cardboard or cloth. Rub the cathode very gently side to side 4-5 times. This will be enough to polish and remove any stains without damaging the platinum tip. Afterwards, rinse the probe with deionized or distilled water and install a new membrane cap using fresh electrolyte and follow DO Probe Preparation page 31.

Important

In order to have accurate and stable measurements, it is important that the membrane surface to be in perfect condition. This semipermeable membrane isolates the sensor elements from the environment but allows oxygen to enter. If any dirt is observed on the membrane, rinse carefully with distilled or deionized water. If imperfections still exist, or any damage is evident (such as wrinkles or tears-holes), the membrane should be replaced. Make sure that the O-Ring sits properly in the membrane cap.

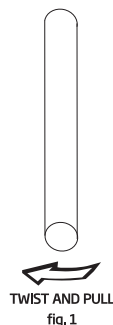

TROUBLESHOOTING GUIDE

Symptoms	Problems	Solution
Readings fluctuate up and down (noise).	DO: DO probe electrolyte contains entrapped gas.	Remove cap. Refill, tap and reinstall.
The display shows DO reading blinking.	Out of range in DO scale.	Verify area of cathode is free of bubbles inside cap. Verify solution movement past membrane. Remove cap, inspect and clean if necessary. Install new cap, fresh electrolyte with no bubbles, permit longer polarization. Stir or increase flow rate.
The meter does not measure temperature. "-- --" is displayed on second LCD line.	Broken temperature sensor.	Replace the probe.
At startup the meter displays all LCD tags permanently.	One of the keys is stuck.	Check the keyboard or contact your local Hanna Instruments Office.
CAL "Prod" message at startup.	Instrument was not factory calibrated or lost factory calibration.	Contact your local Hanna Instruments Office for help.

Dissolved Oxygen Specifications		
DO	Range	0.00 to 45.00 ppm (mg/L); 0.0 to 300.0‰;
	Resolution	0.01 ppm (mg/L); 0.1‰;
	Accuracy @ 25 °C / 77 °F	±1.5% of reading ±1 digit;
	Calibration	One or two points at 0% (HI7040) and 100% (water saturated air)
	Temperature Compensation	0.0 to 50.0 °C; (32.0 to 122 °F)
	Salinity Compensation	0 to 40 g/L; (with 1 g/L resolution)
	Altitude Compensation	-500 to 4,000 m (-1640 to 13120'); (with 100 m (328') resolution)
	Probe	HI764080
	Log Feature	Up to 1000 records organized in: Manual Log on Demand (Max. 200 logs) Manual Log on Stability (Max. 200 logs) Interval Logging (100 lots, Max. 600 logs/lot)
Temperature	Range	-20.0 to 120.0 °C; -4.0 to 248.0 °F
	Resolution	0.1 °C; 0.1 °F
	Accuracy	±0.5 °C; ±0.9 °F
Additional Specifications	PC Interface	Micro USB
	Storage Interface	USB
	Power Supply	5 VDC Adapter (included)
	Environment	0-50 °C (32-122 °F) Max 95% RH non-condensing
	Dimensions	202 x 140 x 12 mm (7.9 x 5.5 x 0.5")
	Weight	250 g (8.82 oz)

DO

HI7040L	Zero Oxygen Solution
HI7041S	Refilling Electrolyte Solution, 30 mL
HI764080	Spare DO probe
HI764080A/P	5 spare membranes

Other Accessories

HI75110/220U	Voltage adapter from 115 VAC to 5 VDC (USA plug)
HI75110/220E	Voltage adapter from 230 VAC to 5 VDC (European plug)
HI76404W	Electrode holder
HI2000WCW	Wall cradle
HI2000BCW	Bench cradle
HI920015	Micro USB cable

Warranty

The **edge[®] DO** is warranted for two years against defects in workmanship and materials when used for their intended purpose and maintained according to instructions. Electrodes and probes are warranted for six months. This warranty is limited to repair or replacement free of charge.

Damage due to accidents, misuse, tampering or lack of prescribed maintenance is not covered.

If service is required, contact your local Hanna Instruments Office. If under warranty, report the model number, date of purchase, serial number and the nature of the problem. If the repair is not covered by the warranty, you will be notified of the charges incurred. If the instrument is to be returned to Hanna Instruments, first obtain a Returned Goods Authorization (RGA) number from the Technical Service department and then send it with shipping costs prepaid. When shipping any instrument, make sure it is properly packed for complete protection.

Hanna Instruments reserves the right to modify the design, construction or appearance of its products without advance notice.

World Headquarters

Hanna Instruments Inc.
Highland Industrial Park
584 Park East Drive
Woonsocket, RI 02895 USA
www.hannainst.com

Local Office

Hanna Instruments USA
270 George Washington Highway
Smithfield, RI 02917
Phone: 800.426.6287
Fax: 401.765.7575
e-mail: tech@hannainst.com