

Instruction Manual

HI8510 • HI8512 HI8710 • HI8711 HI8720

Panel Mounted pH and ORP Indicators and Controllers



Dear Customer,
Thank you for choosing a Hanna Instruments product.
Please read this instruction manual carefully before using these instruments.

This manual will provide you with the necessary information for correct use of these instruments, as well as a precise idea of their versatility. If you need additional technical information, do not hesitate to e-mail us at tech@hannainst.com or view our worldwide contact list at www.hannainst.com.

WARRANTY

HI8510, HI8512, HI8710, HI8711 and HI8720 are guaranteed for two years against defects in workmanship and materials when used for their intended purpose and maintained according to instructions. Electrodes and probes are guaranteed for six months. This warranty is limited to repair or replacement free of charge.

Damage due to accidents, misuse, tampering or lack of prescribed maintenance is not covered.

If service is required, contact your local Hanna Instruments Office. If under warranty, report the model number, date of purchase, serial number and the nature of the problem. If the repair is not covered by the warranty, you will be notified of the charges incurred. If the instrument is to be returned to Hanna Instruments, first obtain a Returned Goods Authorization number from the Technical Service department and then send it with shipping costs prepaid. When shipping any instrument, make sure it is properly packed for complete protection.

TABLE OF CONTENTS

PRELIMINARY EXAMINATION	3
GENERAL DESCRIPTION	3
MECHANICAL DIMENSIONS	4
FUNCTIONAL DESCRIPTION HI8510	5
FUNCTIONAL DESCRIPTION HI8512	7
FUNCTIONAL DESCRIPTION HI8710	9
FUNCTIONAL DESCRIPTION HI8711	12
FUNCTIONAL DESCRIPTION HI8720	15
SPECIFICATIONS	18
INITIAL PREPARATION	21
OPERATIONAL GUIDE	24
pH CALIBRATION	28
pH VALUES AT VARIOUS TEMPERATURE	30
pH DIAGNOSTIC TESTS	31
ORP DIAGNOSTIC TESTS	33
LED INDICATION	34
TAKING REDOX MEASUREMENTS.....	35
ELECTRODE MAINTENANCE	37
SUGGESTED INSTALLATIONS.....	40
ACCESSORIES	42

PRELIMINARY EXAMINATION

Remove the instrument from the packing material and examine it carefully to make sure that no damage has occurred during shipping. If there is any noticeable damage, please contact your local Hanna Instruments Office.

Each model is supplied with:

- Transparent Splash-proof Front Cover
- Mounting Brackets
- Instruction Manual

Note: Save all packing materials until you are sure that the instrument functions correctly. All defective items must be returned in the original packing materials together with the supplied accessories.

GENERAL DESCRIPTION

HI8510 and **HI8512** pH and ORP panel-mounted indicators, and **HI8710**, **HI8711** and **HI8720** pH and ORP controllers, are ideal for process control monitoring in a wide range of industrial applications.

These instruments have been designed for easy and fast installation, and are provided with membrane keypads on the front panel, large display and autodiagnostic functions.

All connections are made through screw terminals on the rear panel.

Each model accepts either a direct input from a pH or ORP electrode or from a transmitter through 4-20mA input. The instrument also provides $\pm 5V$ power output and input terminals for amplified electrodes.

Moreover, you can choose the output configuration for connecting a recorder or a PLC, between 0-20 or 4-20 mA.

Note: In order to avoid damages and erroneous readings:

- do never connect more than one electrode type (BNC, amplified or input transmitter) to the instrument.
- do never use both the 0-20 mA and 4-20 mA recorder outputs at the same time.

Other features include over time control function, selection of the dosing direction (ACID, ALKALINE - **HI8710**; OXID, REDUC - **HI8720**) and the possibility to set dosing action mode (OFF/AUTO/ON).

MECHANICAL DIMENSIONS

The meters are provided with a black anodized aluminum body, front and back panels in shockproof ABS plastic and a transparent splash-proof front cover.

Front view of the panel-mounted unit

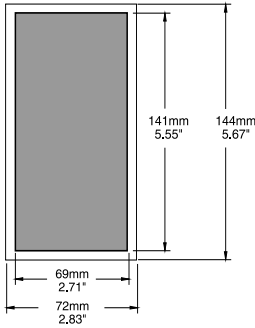

The dimensions show the cutout size for the installation.

Side view of the panel-mounted unit

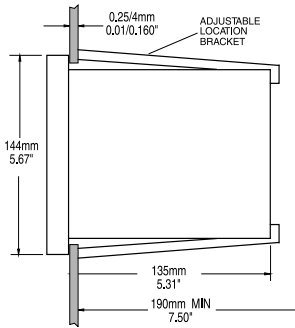

Adjustable location brackets (supplied with the meter) allow the indicator to slide into the cutout and will hold the unit securely in place. 190 mm (7.50") is the minimum space required to install the indicator with complete wiring.

FUNCTIONAL DESCRIPTION HI8510

FRONT PANEL

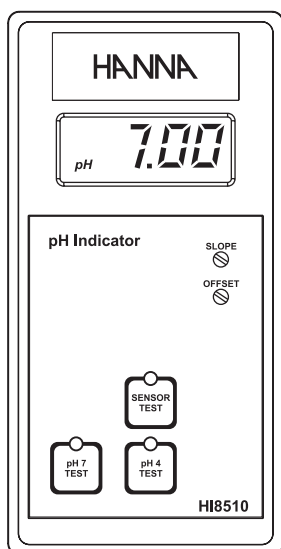

Keypad

- SENSOR TEST** To display the mV reading of the electrode and, therefore, verify its working condition
- pH7 TEST** To verify the internal circuit of the meter in terms of Offset compensation
- pH4 TEST** To verify the amplifier circuit of the meter

Note: Each time a key is pressed the corresponding LED is turned ON.

Trimmers

- OFFSET** For Offset calibration
- SLOPE** For Slope calibration

REAR PANEL HI8510

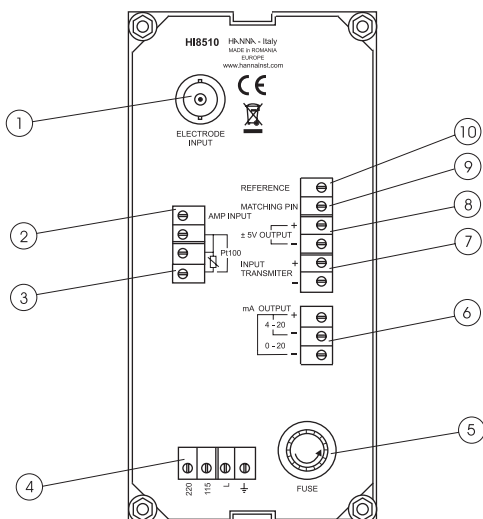

1. BNC socket for pH electrode
2. Input from amplified electrode
3. Connections for Pt100 temperature sensor
4. Power supply terminals
5. Fuse holder
6. Recorder output terminals
7. Connection to the transmitter
8. Power for amplified electrode
9. Connection for matching pin
10. Connection for reference electrode



Unplug the instrument from the power supply before replacing the fuse.
 Only one of BNC, AMP INPUT or INPUT TRANSMITTER connectors can be used at a moment. Leave the other two inputs unconnected.
 Only one of the two terminals 4-10 mA and 0-20 mA can be used at one moment. Leave the other unconnected.

FUNCTIONAL DESCRIPTION HI8512

FRONT PANEL

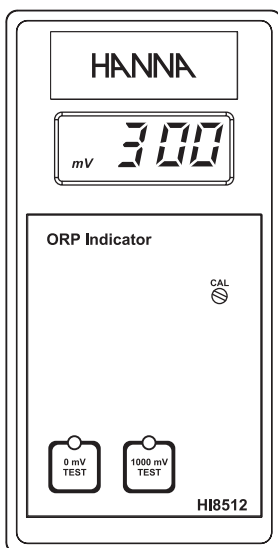

Keypad

0 mV TEST To verify the instrument calibration at 0 mV

1000 mV TEST To verify the slope at 1000 mV

Note: Each time a key is pressed the corresponding LED is turned ON.

Trimmers

CAL For ORP calibration

REAR PANEL HI8512

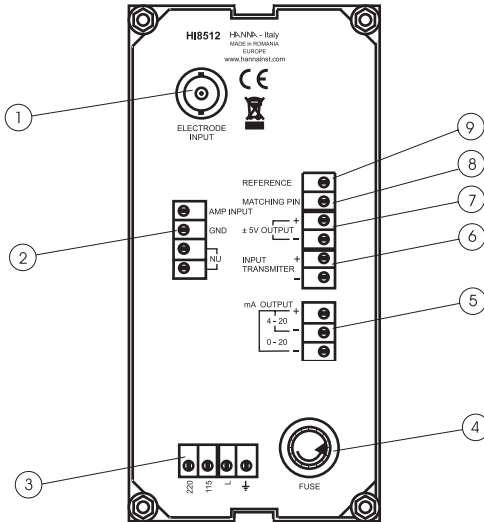

1. BNC socket for ORP electrode
2. Input from amplified electrode
3. Power supply terminals
4. Fuse holder
5. Recorder output terminals
6. Connection to the transmitter
7. Power for amplified electrode
8. Connection for matching pin
9. Connection for reference electrode



Unplug the instrument from the power supply before replacing the fuse.
Only one of BNC, AMP INPUT or INPUT TRANSMITTER connectors can be used at a moment. Leave the other two inputs unconnected.
Only one of the two terminals 4-10 mA and 0-20 mA can be used at one moment. Leave the other unconnected.

FUNCTIONAL DESCRIPTION HI8710

FRONT PANEL

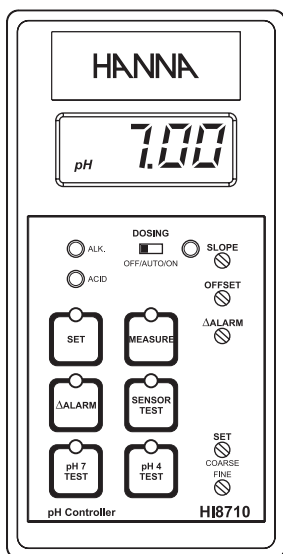

Keypad

SET	To set the pH dosage limit
MEASURE	To enter measurement mode and to enable diagnostic tests
SENSOR TEST	To display electrode mV reading and verify its working condition
Δ ALARM	To display & set alarm tolerance
pH7 TEST	To verify Offset compensation
pH4 TEST	To verify amplifier circuit

Note: Each time a key is pressed the corresponding LED is turned ON or changes its blinking behavior (Δ ALARM).

Trimmers

OFFSET	For Offset calibration
SLOPE	For Slope calibration
Δ ALARM	To set the alarm tolerance
SET/COARSE	To coarsely adjust the setpoint
SET/FINE	To finely adjust the setpoint

LEDs

ACID	(blinking)	Shows that acid dosage is active
ALK.	(blinking)	Shows that alkaline dosage is active
△ALARM	(blinking)	Indicates an active alarm

DOSAGE MODE SWITCH Blinks when the dosing switch is in **OFF** or **ON** position.

SWITCH

OFF/AUTO/ON

To set the dosing mode:

- **OFF** - dosing is disabled
- **AUTO** - automatic dosage, depending on setpoint value and dosing selection
- **ON** - dosing always active

REAR PANEL HI8710

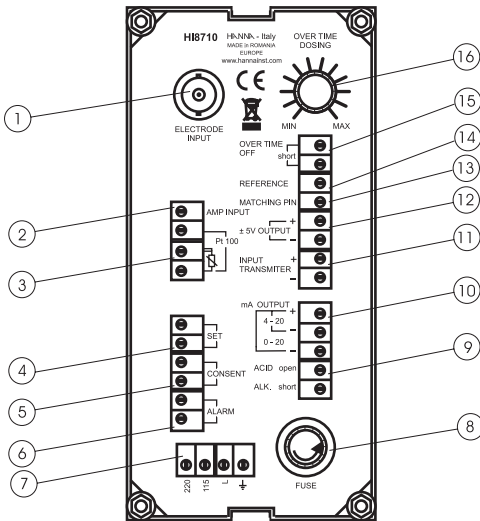

1. BNC socket for pH electrode
2. Input from amplified electrode
3. Connections for Pt100 temperature sensor
4. Connections for dosing pump
5. Reduc/Oxid dosage consent terminals
6. Alarm contacts
7. Power supply terminals
8. Fuse holder
9. Acid/Alkaline dosage selection terminals
10. Recorder output contacts
11. Connection to the transmitter
12. Power for amplified electrode
13. Connection for matching pin
14. Connection for reference electrode
15. Disable overtime connection
16. Overtime set knob (about 5 to 60 min)



Unplug the instrument from the power supply before replacing the fuse.
 Only one of BNC, AMP INPUT or INPUT TRANSMITTER connectors can be used at a moment. Leave the other two inputs unconnected.
 Only one of the two terminals 4-10 mA and 0-20 mA can be used at one moment. Leave the other unconnected.

FUNCTIONAL DESCRIPTION HI8711

FRONT PANEL

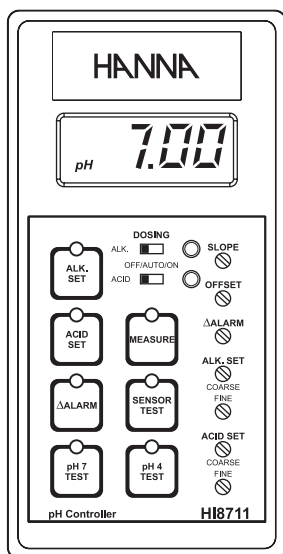

Keypad

ALK. SET	To set the working point of basic dosage
ACID SET	To set the working point of acid dosage
MEASURE	To enter measurement mode and to enable diagnostic tests
SENSOR TEST	To display electrode mV reading and, therefore, verify its working condition
ΔALARM	To display and set the alarm tolerance
pH7 TEST	To verify Offset compensation
pH4 TEST	To verify amplifier circuit

Note: Each time a key is pressed the corresponding LED is turned ON or changes its blinking behavior (ALK.SET, ACID SET, ΔALARM).

Trimmers

SLOPE	For Slope calibration
OFFSET	For Offset calibration
△ALARM	To set the tolerance of the alarm
ALK. SET	
COARSE	To coarsely adjust alkaline setpoint
FINE	To finely adjust alkaline setpoint
ACID SET	
COARSE	To coarsely adjust acid setpoint
FINE	To finely adjust acid setpoint

LEDs

ALK. SET	(Blinking)	Show that basic dosage is active
ACID SET	(Blinking)	Show that acid dosage is active
△ALARM	(Blinking)	Indicate active alarm
ALK. DOSAGE MODE SWITCH	(Blinking)	Shows that the alkaline dosage switch is in OFF or ON position
ACID DOSAGE MODE SWITCH	(Blinking)	Shows that the acid dosage switch is in OFF or ON position

Switches

ALK. OFF/AUTO/ON

To set the dosing mode:

- **OFF** - dosing is disabled
- **AUTO** - automatic dosage, depending on alkaline setpoint value
- **ON** - dosing always active

ACID OFF/AUTO/ON

To set the dosing mode (see above) for acid setpoint value.

REAR PANEL HI8711

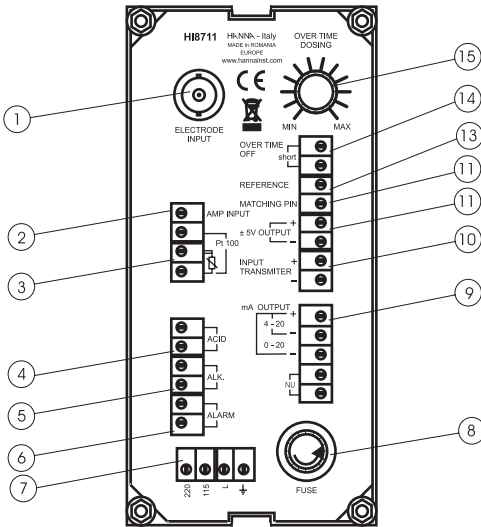

1. BNC socket for pH electrode
2. Input from amplified electrode
3. Connections for Pt100 temperature sensor
4. Connections for dosing pump for acid
5. Connections for dosing pump for base
6. Alarm contacts
7. Power supply terminals
8. Fuse holder
9. Recorder output contacts
10. Connections to the transmitter
11. Power for amplified electrode
12. Connection for matching pin
13. Connection for reference electrode
14. Disable overtime connection
15. Overtime set knob (about 5 to 60 min)



Unplug the instrument from the power supply before replacing the fuse.
 Only one of BNC, AMP INPUT or INPUT TRANSMITTER connectors can be used at a moment. Leave the other two inputs unconnected.
 Only one of the two terminals 4-10 mA and 0-20 mA can be used at one moment. Leave the other unconnected.

FUNCTIONAL DESCRIPTION HI8720

FRONT PANEL

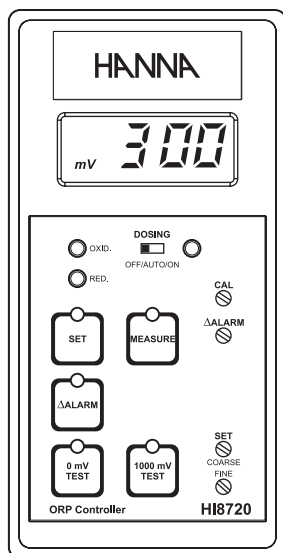

Keypad

SET	To set the working point of ORP dosage
MEASURE	To enter measurement mode and to enable diagnostic tests
ΔALARM	To display and set the alarm tolerance
0 mV TEST	To verify the instrument calibration at 0 mV
1000 mV TEST	To verify the slope at 1000mV

Note: Each time a key is pressed the corresponding LED is turned ON or changes its blinking behavior (ΔALARM).

Trimmers

CAL	For ORP calibration
△ALARM	To display and set the alarm tolerance
SET/COARSE	To coarsely adjust the setpoint
SET/FINE	To finely adjust the setpoint

LEDs

OXID (Blinking)	Show that the oxidant dosage is active
RED. (Blinking)	Show that the reductant dosage is active
△ALARM (Blinking)	Indicate an active alarm
DOSAGE MODE SWITCH	Blinks when the dosage switch is in OFF or ON position.

Switches

OFF/AUTO/ON

To set the dosing mode:

- **OFF** - dosing is disabled
- **AUTO** - automatic dosage, depending on setpoint value and dosing selection
- **ON** - dosing always active

REAR PANEL HI8720

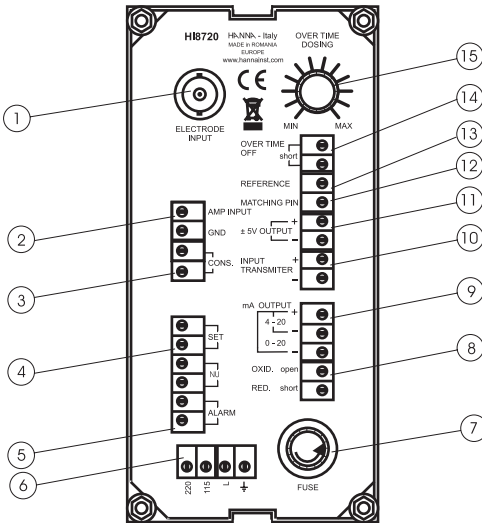

1. BNC socket for ORP electrode
2. Input from amplified electrode
3. Oxid/Reduc dosage consent terminals
4. Connections for dosing pump
5. Alarm contacts
6. Power supply terminals
7. Fuse holder
8. OXID/RED. dosage selection terminals
9. Recorder output contacts
10. Connections to the transmitter
11. Power for amplified electrode
12. Connection for reference electrode
13. Disable overtime connection
15. Overtime set knob (about 5 to 60 min)



Unplug the instrument from the power supply before replacing the fuse.
 Only one of BNC, AMP INPUT or INPUT TRANSMITTER connectors can be used at a moment. Leave the other two inputs unconnected.
 Only one of the two terminals 4-10 mA and 0-20 mA can be used at one moment. Leave the other unconnected.

SPECIFICATIONS

HI8510

INPUT	Electrode	Transmitter
RANGE	0.00 to 14.00 pH	
RESOLUTION	0.01 pH	
ACCURACY (@25 °C/77 °F)	±0.02 pH (0 to 100 °C) ±0.05 pH (-20 to 0 °C)	±0.5%
INPUTS	High impedance 10 ¹² Ohm; Reference and Matching pin inputs are available	4 to 20 mA
POWER OUTPUT	± 5 Vcc; 150 mA max load for amplified electrodes	
CALIBRATION	Offset: ±2 pH with OFFSET trimmer; Slope: 80 to 110% with SLOPE trimmer	
TEMPERATURE COMPENSATION	Fixed or automatic with Pt100 from -20 to 100 °C (-4 to 212 °F)	
RECORDER OUTPUT	0-20 mA or 4-20 mA (isolated)	
BACKLIGHT	Continuous ON	
POWER SUPPLY	115 or 230 Vac; 60/50 Hz	
ENCLOSURE	Black anodized aluminum body; front and back with ABS; transparent splash-proof front cover	
ENVIRONMENT	-10 to 50 °C (14 to 122 °F); RH max 95% non condensing	
PANEL CUTOUT	141 x 69 mm (5.6 x 2.7")	
WEIGHT	1 kg (2.2 lb.)	

HI8512

INPUT	Electrode	Transmitter
RANGE	±1000 mV	
RESOLUTION	1 mV	
ACCURACY (@25 °C/77 °F)	± 5 mV	±0.5%
INPUTS	High impedance 10 ¹² Ohm; Reference and Matching pin inputs are available	4 to 20 mA
POWER OUTPUT	± 5 Vcc; 150 mA max load for amplified electrodes	
CALIBRATION	Offset: ±200 mV with CAL trimmer	
RECORDER OUTPUT	0-20 mA or 4-20 mA (isolated)	
BACKLIGHT	Continuous ON	
POWER SUPPLY	115 or 230 Vac; 60/50 Hz	
ENCLOSURE	Black anodized aluminum body; front and back with ABS; transparent splash-proof front cover	
ENVIRONMENT	-10 to 50 °C (14 to 122 °F); RH max 95% non condensing	
PANEL CUTOUT	141 x 69 mm (5.6 x 2.7")	
WEIGHT	1 kg (2.2 lb.)	

HI8710

INPUT	Electrode	Transmitter
RANGE	0.00 to 14.00 pH	
RESOLUTION	0.01 pH	
ACCURACY (@25 °C/77 °F)	±0.02 pH (0 to 100 °C) ±0.05 pH (-20 to 0 °C)	±0.5%
INPUTS	High impedance 10 ¹² Ohm; Reference and Matching pin inputs are available	4 to 20 mA
POWER OUTPUT	±5 Vcc; 150 mA max load for amplified electrodes	
CALIBRATION	Offset: ±2 pH with OFFSET trimmer; Slope: 80 to 110% with SLOPE trimmer	
TEMPERATURE COMPENSATION	Fixed or automatic with Pt100 from -20 to 100 °C (-4 to 212 °F)	
RECORDER OUTPUT	0-20 mA or 4-20 mA (isolated)	
SETPOINT RELAY	1, isolated, 2 A, Max 240 V, resistive load, 1000000 strokes (not fuse protected)	
SETPOINT RANGE	0.00 to 14.00 pH	
ALARM RELAY	1, isolated, 2 A, Max 240 V, resistive load, 1000000 strokes (not fuse protected)	
ALARM RANGE	0.2 to 3.00 pH	
CONSENT RELAY	1, isolated, 2 A, Max 240 V, resistive load, 1000000 strokes (not fuse protected)	
BACKLIGHT	Continuous ON	
POWER SUPPLY	115 or 230 Vac; 60/50 Hz	
ENCLOSURE	Black anodized aluminum body; front and back with ABS; transparent splash-proof front cover	
ENVIRONMENT	-10 to 50 °C (14 to 122 °F); RH max 95% non condensing	
PANEL CUTOUT	141 x 69 mm (5.6 x 2.7")	
WEIGHT	1 kg (2.2 lb.)	

HI8711

INPUT	Electrode	Transmitter
RANGE	0.00 to 14.00 pH	
RESOLUTION	0.01 pH	
ACCURACY (@25 °C/77 °F)	±0.02 pH (0 to 100 °C) ±0.05 pH (-20 to 0 °C)	±0.5%
INPUTS	High impedance 10 ¹² Ohm; Reference and Matching pin inputs are available	4 to 20 mA
POWER OUTPUT	±5 Vcc; 150 mA max load for amplified electrodes	
CALIBRATION	Offset: ±2 pH with OFFSET trimmer; Slope: 80 to 110% with SLOPE trimmer	
TEMPERATURE COMPENSATION	Fixed or automatic with Pt100 from -20 to 100 °C (-4 to 212 °F)	

RECORDER OUTPUT	0-20 mA or 4-20 mA (isolated)
SETPOINT RELAY	1, isolated, 2 A, Max 240 V, resistive load, 1000000 strokes (not fuse protected)
SETPOINT RANGE	0.00 to 14.00 pH
ALARM RELAY	1, isolated, 2 A, Max 240 V, resistive load, 1000000 strokes (not fuse protected)
ΔALARM RANGE	0.2 to 3.00 pH
DOSING CONTROL	OFF/AUTO/ON with selection switch
OVER DOSING CONTROL	Adjustable, from 5 min to 60 min with knob or Disable by wire strap - on rear panel
BACKLIGHT	Continuous ON
POWER SUPPLY	115 or 230 Vac; 60/50 Hz
ENCLOSURE	Black anodized aluminum body; front and back with ABS; transparent splash-proof front cover
ENVIRONMENT	-10 to 50 °C (14 to 122 °F); RH max 95% non condensing
PANEL CUTOUT	141 x 69 mm (5.6 x 2.7")
WEIGHT	1 kg (2.2 lb.)

HI8720

INPUT	Electrode	Transmitter
RANGE	±1000 mV	
RESOLUTION	1 mV	
ACCURACY (@25 °C/77 °F)	±5 mV	±0.5%
INPUTS	High impedance 10 ¹² Ohm; Reference and Matching pin inputs are available	4 to 20 mA
POWER OUTPUT	±5 Vcc; 150 mA max load for amplified electrodes	
CALIBRATION	Offset: ±2 pH with OFFSET trimmer; Slope: 80 to 110% with SLOPE trimmer	
RECORDER OUTPUT	0-20 mA or 4-20 mA (isolated)	
SETPOINT RELAY	1, isolated, 2 A, Max 240 V, resistive load, 1000000 strokes (not fuse protected)	
SETPOINT RANGE	0.00 to 14.00 pH	
ALARM RELAY	1, isolated, 2 A, Max 240 V, resistive load, 1000000 strokes (not fuse protected)	
ΔALARM RANGE	10 to 300 mV	
DOSING CONTROL	1, isolated, 2 A, Max 240 V, resistive load, 1000000 strokes (not fuse protected)	
OVER DOSING CONTROL	Adjustable, from 5 min to 60 min with knob or Disable by wire strap - on rear panel	
BACKLIGHT	Continuous ON	
POWER SUPPLY	115 or 230 Vac; 60/50 Hz	
ENCLOSURE	Black anodized aluminum body; front and back with ABS; transparent splash-proof front cover	
ENVIRONMENT	-10 to 50 °C (14 to 122 °F); RH max 95% non condensing	
PANEL CUTOUT	141 x 69 mm (5.6 x 2.7")	
WEIGHT	1 kg (2.2 lb.)	

INITIAL PREPARATION

- Connect a 3-wire cable to the power supply terminal according to the voltage level as indicated, and pay particular attention to the correct line, earth and neutral connections.
- For **BNC electrodes**, connect the electrode to the BNC plug on the rear panel.

The instruments are equipped with differential input. To benefit from differential input advantages, connect the proper electrode wire (if available) or a cable with a potential matching pin, to the Matching Pin (terminal 4).

When the Matching Pin cannot be immersed together with the electrode in the solution, disable the differential input by shorting the Electrode reference and the Matching Pin terminals with a jumper wire (terminals 3 and 4).

- For **amplified electrodes** connect the electrode pH input wire to the **AMP INPUT** terminal (1), the electrode power supply wires to the ± 5 V terminals (7, 8) and the electrode reference wire to the reference terminal (5). Make a short between Reference and Matching pin terminals (5, 6).

If the amplified electrode is provided with BNC connector, connect the electrode to the BNC input and the power supply wires to the ± 5 V terminals (7, 8).

- For **Inputs from transmitter**, connect the 2 signal wires of the analog transmitter to the "INPUT TRANSMITTER" terminals (7, 8), while paying attention to the indicated polarity.

Note: Only one of BNC, AMP INPUT or INPUT TRANSMITTER connectors can be used at one moment. Leave the other two inputs unconnected.

- **Recorder output terminals:** these contacts are used for connection to a recorder. The output can be 0-20 mA or 4-20 mA depending on the connection, and is proportional to the pH or ORP reading.

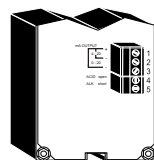
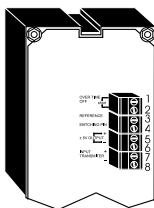
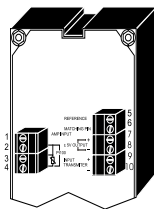
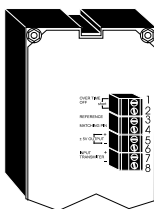
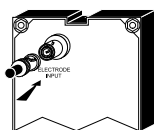
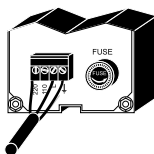

Connect the “+” wire of the recorder to the terminal 1 on the instrument and the other wire (common) to terminal 2 for 4-20 mA recorder output or to terminal 3 for 0-20 mA recorder output.

Note: Only one recorder output connection is possible. In order to avoid malfunction leave the unused terminal unconnected.

- **Pt100 terminals:** these contacts are used to connect the Pt100 temperature sensor for automatic temperature compensation of pH readings. If temperature compensation is not required, connect a 110 Ohm/0.25W resistor across the terminals (equivalent to a fixed temperature of 25 °C/77 °F).

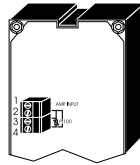

Connect the Pt100 terminals to terminals 3 and 4. In case the wires are shielded, connect the shield wire to terminal 2.

- The **HI8710** models are single dosage controllers with acid/alkaline selection.

If acid dosage is needed (e.g. in chromium VI reduction), leave open the ACID/ALK. selection terminals (4 and 5), while for alkaline dosage (e.g. in cyanide oxidation), make a short circuit across the ACID/BASE selection terminals (4 and 5) with a jumper wire.

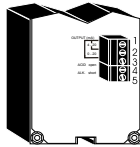

- The **HI8720** models are single dosage controllers with oxidant/reductant selection.

If oxidant dosage is needed (e.g. in cyanide oxidation), leave open the OXID/RED. selection terminals (4 and 5). The dosing is activated when the reading falls below the setpoint value. For reductant dosage (e.g. in chromium VI reduction), make a short circuit across the OXID/RED. selection terminals (4 and 5) with a jumper wire. The dosing is activated when the reading exceeds the setpoint value.

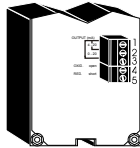

- **SET** contacts (**HI8710** and **HI8720**) (see picture terminals 1, 2): these contacts (max. 2A, 240 V) are used to connect the dosing pump, and act only as a switch for the power to the drive.

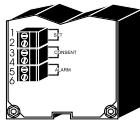

- **ACID** contacts (**HI8711**) (see picture, terminals 1 and 2): these contacts are used to connect the dosing pump for acid, and act as a switch for the power to the drive.

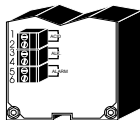

- **ALK.** contact (**HI8711**) (see picture, terminals 3 and 4): these contacts are used to connect the dosing pump for base, and act as a switch for the power to the drive.

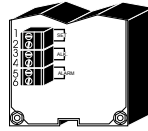

- **CONSENT** contacts (**HI8710** and **HI8720**, see picture, terminals 3 and 4): these contacts (max. 2A, 240V) are used for reduction and oxidation reactions when the pH controller works in conjunction with an ORP controller and vice versa.

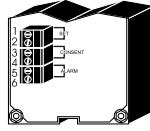

In these applications, the consent contacts of both meters are connected together to link the ORP and pH controllers, so that ORP dosage will occur only if the actual pH value is correct. This feature avoids overdosages which may lead to undesirable pollution.

For **HI8710**, the “Consent” contacts (terminals 3 and 4) can be left open if the instrument is used independently as pH controller only.

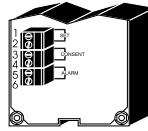

For **HI8720**, the “Consent” contacts (terminals 3 and 4) should be shorted if the instrument is used independently as ORP controller only.

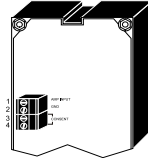

- **ALARM** contacts (**HI8710**, **HI8711** and **HI8720**) (see picture terminals 5, 6): If the pH or ORP measurement are inside the set value tolerance the alarm contact is closed and ALARM LED is OFF (alarm is not active). If the pH or ORP measurement is not within the set value tolerance, the alarm contact is opened and ALARM LED blinks (alarm is active). This ensures that a power down condition will generate an alarm condition.

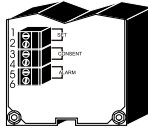

- To set the overtime dosing period rotate the overtime knob to the proper position. The time can be set between approx 5 min to 60 min (from MIN to MAX position). To disable the overtime dosage feature, make a short with a jumper wire between the terminals of the proper connector (see picture, terminals 1 and 2).

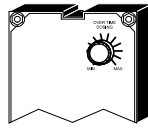

Note: All external cables connected to the rear panel should be ended with cable lugs.

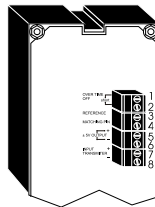

OPERATIONAL GUIDE

All instrument settings are made via front panel keys and trimmers. When a key is pressed, the corresponding LED lights up to show the operating function. If the LED blinks before pressing the key, it will change the blinking style.

If using an assigned electrode, make sure that the meter is calibrated before starting any operation (see "Calibration" section for details). Be sure that the dosage switch is in AUTO position.

DOSING MODE SELECTION

The DOSAGE switch and the corresponding right side LED on the front panel (one for HI8710 & HI8720; two for HI8711) are used to select and indicate the dosing mode.

OFF mode

The dosage is disabled. The corresponding DOSAGE SWITCH LED blinks.



AUTO mode

The dosage is activated and deactivated according with the selected setpoint. The corresponding DOSAGE SWITCH LED is off.

Be sure that the DOSAGE switch is in AUTO position when the meter is in normal operating mode.

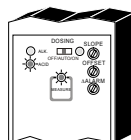

ON mode

The dosage is always activated. The corresponding DOSAGE SWITCH LED blinks.



Note: Two switches are available for HI8711, one for alkaline and the other for acid dosage channel. By putting one of the switches in OFF position, the corresponding dosage relay is deactivated. The ALARM relay is deactivated but the ALARM LED will work in accordance with the setpoint, alarm threshold and input reading.

SET POINTS (HI8710 and HI8720)

To set the working point for pH or ORP dosage, press SET and the display will show the set value. The SET LED turns ON.

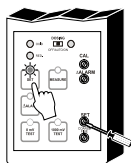

Using a small screwdriver adjust the COARSE and FINE trimmers to display the desired set value.

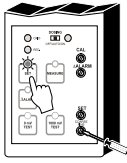

SET POINTS (H18711)

To set the working point for alkaline dosage, press the **ALK. SET** key and the display will show the set value for alkaline dosage. The ALK. SET LED will turn ON if alkaline dosage is deactivated or change blinking style.

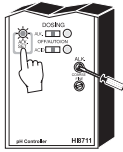

Using a small screwdriver adjust the ALK. SET COARSE and FINE trimmers to display the desired base set value.

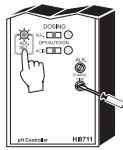

To set the working point for acid dosage, press the **ACID SET** key and the display will show the set value for acid dosage. The ACID SET LED will turn ON if acid dosage is deactivated or change blinking style.

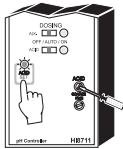

Using a small screwdriver adjust the ACID SET COARSE and FINE trimmers to display the desired acid set value.

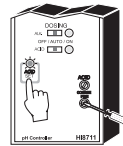

Note: The **ALK.** and the **ACID** setpoints can be set on the entire range 0.00 pH to 14.00 pH using **COARSE** and **FINE** trimmers.

In order to avoid erroneous situations the **ALK.** setpoint value should not exceed the **ACID** setpoint value.

ALARMS (HI8710, HI8711 and HI8720)

To set the alarm tolerance, press Δ ALARM key and the display will show the current value.

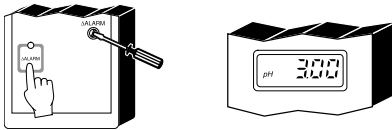

Using a small screwdriver adjust the Δ ALARM trimmer to display the desired tolerance.

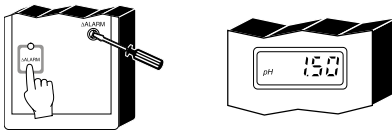

Examples:

For **HI8710**, if the set value is pH3 and the Δ ALARM is 1.5 pH, the instrument generates an alarm every time the pH reading is higher than 4.5 pH or lower than 1.5 pH.

For **HI8711**, if the set values are pH7 and pH8, and the Δ ALARM is 1.5 pH, the instrument generates an alarm every time the pH reading is higher than 9.5 pH or lower than 5.5 pH.

For **HI8720**, if the set value is 300 mV and the Δ ALARM is 100 mV, the instrument generates an alarm every time the ORP reading is higher than 400 mV or lower than 200 mV.

An alarm is generated if the dosing time exceeds the overtime dosage period set (if not disabled).

MEASUREMENTS

After setting the pH (or ORP) and alarm (if available) thresholds, immerse the electrode in the solution to be tested and press **MEASURE**.

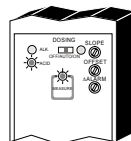

The actual pH or ORP value of the test solution is displayed.

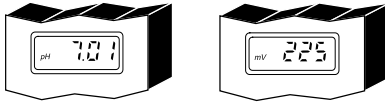

When acid dosage is active, the ACID LED lights up, while during alkaline dosage, the ALK. LED turns on (HI8710 only).

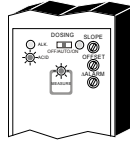

When oxidant dosage is active, the OXID LED lights up, while during reductant dosage, the RED. LED turns on (HI8720 only).

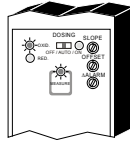

When the dosage switch is in OFF or continuous ON position the corresponding LED blinks (the LED on the right side of the switch).
If the dosing switch is in OFF position the dosing and alarm relays are deactivated and the ALK. or ACID LEDs are OFF.

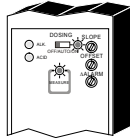

If the dosing switch is in ON position the DOSING relay is always activated and the ALK. or ACID LEDs blink; the ALARM relay is activated and the ALARM LED blinks according with the input reading, setpoint and ALARM threshold.

If the dosing switch is in AUTO position, all relays are controlled depending on measure, setpoint and ALARM threshold.

If overtime dosing function is enabled overtime OFF terminals (1,2) open and the DOSAGE switch is in AUTO or ON position, an ALARM is generated if the dosing time exceeds the overtime set period (overtime knob on the rear panel).

The dosing relay is not deactivated if the DOSAGE switch is in ON position but is deactivated if the switch is in AUTO position, when the overtime period is overpassed.

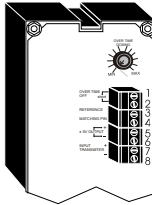

To leave overtime ALARM mode and return to normal operation move the DOSAGE switch in OFF and then in AUTO or ON position again. The dosage and alarm relays will be controlled depending on the measure, setpoint and alarm thresholds. The overtime counter is reinitialized to 0.

Two DOSAGE MODE switches are designed for **HI8711**, one for ACID and the other for ALK. channels. If for any reason one of them is in OFF position the corresponding dosing relay is deactivated. The alarm relay will be activated only in accordance with the other channel. The ALARM LED will work as in AUTO mode.

pH CALIBRATION

Make sure that the instrument is in measurement mode (MEASURE LED is on) before proceeding with calibration.

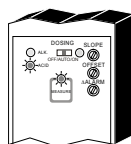

Measure the temperature of the calibration buffer with a reference thermometer.

Remove the protective cap from the electrode. Rinse the pH electrode and the reference thermometer in pH7.01 rinsing solution and then immerse them in pH7.01 buffer solution (HI7007).

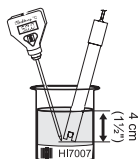

Note: The electrode should be submerged at least 4 cm (1 1/2") into the solution. The thermometer should be located as close as possible to the pH electrode.

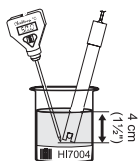

Shake briefly and wait one minute before adjusting the **OFFSET** trimmer to display the buffer solution value, i.e. "pH7.01" at 25 °C (77 °F).

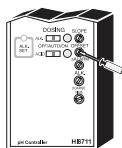

If the buffer solution temperature is different from 25 °C (77 °F), refer to the "pH vs. temperature" chart on page 30 for the appropriate pH value at the noted temperature.

Rinse pH electrode and the reference thermometer thoroughly with pH4.01 rinsing solution, then immerse them in pH4.01 (HI7004) or pH10.01 (HI7010) buffer solution.

Note: For accurate readings, use pH4.01 if you are going to measure acid samples or pH10.01 for alkaline measurements.

Shake briefly and wait one minute before adjusting the **SLOPE** trimmer to display the pH value of the buffer solution, i.e. pH4.01 (or 10.01) at 25 °C (77 °F).

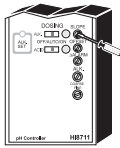

If the buffer solution temperature is different from 25 °C (77 °F), refer to the “pH vs. temperature” chart on page 30 for the appropriate pH value at the noted temperature.

The calibration is now complete and the instrument is ready for use.

Note: If a Pt100 temperature sensor and Matching Pin is used, immerse them into the buffer solutions during calibration together with the electrode.

pH VALUES AT VARIOUS TEMPERATURE

Temperature has an effect on the pH. The calibration buffer solutions are affected by temperature changes to a lesser degree than normal solutions.

Please refer to the following chart to perform the pH calibration:

TEMP		pH BUFFERS				
°C	°F	4.01	6.86	7.01	9.18	10.01
0	32	4.01	6.98	7.13	9.46	10.32
5	41	4.00	6.95	7.10	9.39	10.24
10	50	4.00	6.92	7.07	9.33	10.18
15	59	4.00	6.90	7.05	9.27	10.12
20	68	4.00	6.88	7.03	9.22	10.06
25	77	4.01	6.86	7.01	9.18	10.01
30	86	4.02	6.85	7.00	9.14	9.96
35	95	4.03	6.84	6.99	9.11	9.92
40	104	4.04	6.84	6.98	9.07	9.88
45	113	4.05	6.83	6.98	9.04	9.85
50	122	4.06	6.83	6.98	9.01	9.82
55	131	4.08	6.84	6.98	8.99	9.79
60	140	4.09	6.84	6.98	8.97	9.77
65	149	4.11	6.84	6.99	8.95	9.76
70	158	4.12	6.85	6.99	8.93	9.75

For instance, if the buffer temperature is 25 °C (77 °F), calibrate to read on the display pH4.01 or 7.01 or 10.01. If the buffer temperature is 20 °C, calibrate to read on the display pH4.00 or 7.03 or 10.06. If the buffer temperature is 50 °C, calibrate to read on the display pH4.06 or 6.98 or 9.82.

pH DIAGNOSTIC TESTS

HI8510, HI8710 and HI8711 are provided with autodiagnostic functions that allow to check and troubleshoot any malfunctioning.

The functions are made via front panel keys to isolate the cause of malfunction whether it is due to pH electrode contamination, internal offset circuit or amplifier circuit.

Follow the procedure described below.

First press the **MEASURE** key, then one of the following keys.

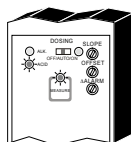

A) *Sensor Test*

Immerse the electrode in pH7.01 buffer solution (**H7007**), press **SENSOR TEST** key and the display shows the mV response of the electrode.

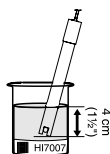

The corresponding LED turns on.



If the electrode is in good working condition, the value should be within ± 30 mV.

A value between 30 and 60 mV or -60 and -30 mV, indicates some contamination of the electrode.

If the value is higher than 60 mV or lower than -60 mV, the contamination is too high and the electrode should be replaced.

B) *Internal Offset Circuit Test*

Press the **pH7 TEST** key and the display should show a value within 7 ± 1 pH, to verify the internal circuit of the meter in terms of the offset compensation.

The corresponding LED turns on.

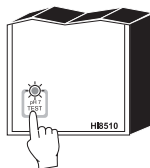

C) *Amplifier Circuit Test*

Press the **pH4 TEST** key and the display should show a value within the 3.30 to 4.30 pH range, to verify the amplifier circuit of the meter.

The corresponding LED turns on.

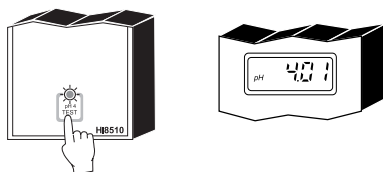

ORP DIAGNOSTIC TESTS

HI8512 and **HI8720** are ORP controllers provided with autodiagnostic functions that allow to check and troubleshoot any malfunctioning. The functions are made via front panel keys to isolate the cause of malfunction.

For **HI8720** only, press **MEASURE** key before proceeding with the following tests.

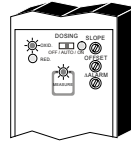

A) *0 mV Test*

Press the **0 mV TEST** key and the display should show a value of 0 ± 10 mV, to verify the “zero” calibration of the instrument. The corresponding LED turns on.

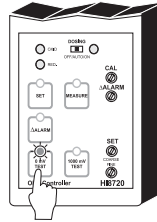

B) *1000 mV Test*

Press the **1000 mV TEST** key and the display should show a value of 1000 ± 20 mV, to verify the slope at 1000 mV. The corresponding LED turns on.

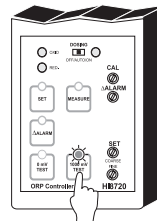

LED INDICATION

All LEDs above the keys indicate the state of each function, whether it is active or the display is indicating the mode.

For HI8711 only

Each LED can be in one of the following states:

- A) **Light on** The mode is displayed on the LCD but is not active, e.g. the alarm setpoint is displayed but the alarm contact is open.
- B) **Light blinking 25% on, 75% off** The mode is not displayed but it is active, e.g. the alarm contact is opened but the alarm setpoint is not displayed.
- C) **Light blinking 75% on, 25% off** The mode is active and being displayed.
- D) **Light off** The function is neither active nor displayed.

TAKING REDOX MEASUREMENTS

Redox measurements allow the quantification of the solution oxidizing/reducing power, and are commonly expressed in mV.

Oxidation may be defined as the process during which a molecule (or an ion) loses electrons and reduction as the process by which electrons are gained.

Oxidation is always coupled together with reduction, so that as one element gets oxidized, the other is automatically reduced, therefore the term oxidation-reduction is frequently used.

Redox potentials are measured by an electrode capable of absorbing or releasing electrons without causing any chemical reaction.

The most common ORP electrodes are provided with gold or platinum surfaces; gold features a higher resistance than platinum in conditions of strong oxidation, while platinum is preferred for measuring oxidizing solutions containing halides, and for general purposes.

When a platinum electrode is immersed in an oxidizing solution, a monomolecular layer of oxygen is developed on its surface. This layer does not prevent the electrode from functioning, but it increases the response time. The opposite effect is obtained when the platinum surface absorbs hydrogen in the presence of reducing mediums. This phenomenon is rough on the electrode.

To make correct redox measurements, it is necessary that the surface of the electrode is clean and smooth, and that a preventive treatment is performed.

Because the Pt/PtO system depends on the solution pH level, the electrode pre-treatment may be determined by the pH and the redox potential of the solution to be measured.

Generally, if the ORP (mV) reading corresponding to the pH solution value is higher than the value in the table below, an oxidizing pre-treatment is necessary; otherwise a reducing pre-treatment is necessary:

pH	mV	pH	mV	pH	mV	pH	mV	pH	mV
0	990	1	920	2	860	3	800	4	740
5	680	6	640	7	580	8	520	9	460
10	400	11	340	12	280	13	220	14	160

Reducing pre-treatment: immerse the electrode for some minutes in HI7091 solution.

Oxidizing pre-treatment: immerse the electrode for some minutes in **HI7092** solution.

If no pre-treatment is performed, the electrode will have long response times.

If working with refillable electrodes, always check the internal electrolyte level and refill with **HI7071** solution, if necessary (the level must be at least 2.5 cm below the filling hole).

If measurements are taken in solutions containing sulfides or proteins, the cleaning of the electrode junction must be performed (see "Cleaning Procedure" section for details).

To check the correct functioning of the ORP electrode, immerse it into **HI7021** test solution and verify that the reading is within 240 ± 20 mV.

After the test, rinse the electrode thoroughly with water and proceed with the oxidizing or reducing pre-treatment before taking any measurement.

When not in use, the electrode tip should be kept moist and far from any type of mechanical stress which might cause damage. For this reason, it is recommended to store the electrode with a few drops of **HI70300** storage solution in the supplied protective cap.

ELECTRODE MAINTENANCE

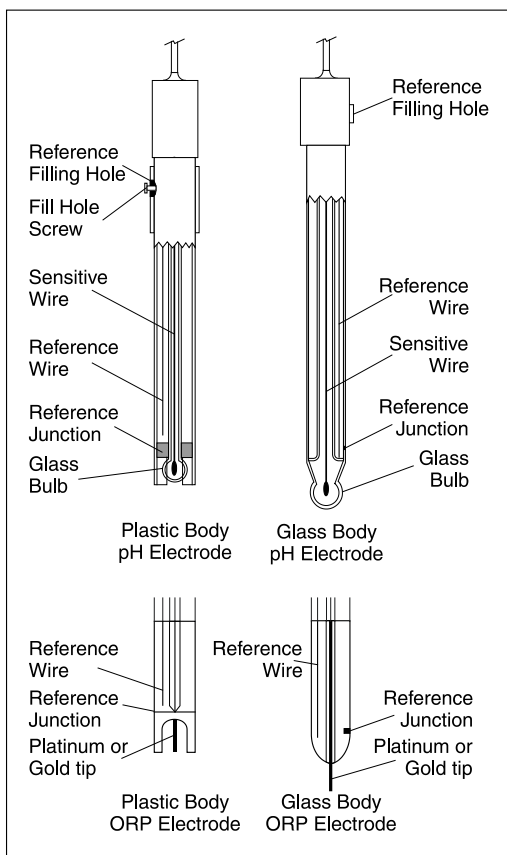

PREPARATION PROCEDURE

Remove the protective cap.

DO NOT BE ALARMED IF ANY SALT DEPOSITS ARE PRESENT. This is normal with electrodes and they will disappear when rinsed with water.

During transport tiny air bubbles may form inside the glass bulb, and the electrode cannot function properly under these conditions. Remove the bubbles by "shaking down" the electrode as you would do with a glass thermometer.

If the bulb and/or junction are dry, soak the electrode in HI70300 storage solution for at least one hour.

For refillable electrodes:

If the internal electrolyte solution is more than 1 cm (1/2") below the filling hole, add **HI7082** solution (3.5M KCl) for double junction electrodes or **HI7071** (3.5M KCl+ AgCl) for single junction electrodes. For a faster response unscrew the filling hole screw during measurements.

For AmpHel® electrodes:

If the electrode does not respond to pH changes, the battery is run down and the electrode should be replaced.

MEASUREMENT

Rinse the electrode tip with distilled water.

Immerse the electrode tip (4 cm) in the sample and stir gently for approximately 30 seconds.

For a faster response and to avoid cross contaminations, before taking measurements, rinse the electrode tip with some solution to be tested.

STORAGE

To minimize clogging and assure a quick response time, the electrode glass bulb and junction should be kept moist at any time.

Store the electrode with a few drops of **H70300** storage solution in the protective cap (in its absence, use **HI7071** electrolyte for single junction, or **HI7082** for double junction electrodes).

Follow the above "Preparation Procedure" before taking measurements.

Note: NEVER STORE THE ELECTRODE IN DISTILLED WATER OR DRY.

PERIODIC MAINTENANCE

Inspect electrode and cable. The cable used for the connection to the meter must be intact and there must be no points of broken insulation on the cable or cracks on the electrode stem or bulb.

Connectors must be perfectly clean and dry. If any scratches or cracks are noted, replace the electrode.

Rinse off any salt deposits with water.

For refillable electrodes:

Refill the electrode with fresh electrolyte solution (**HI7071** for single junction electrodes or **HI7082** for double junction). Allow the electrode to stand upright for 1 hour.

Follow the above "Storage Procedure".

AmpHel® is a registered Trademark of "Hanna Instruments"

CLEANING PROCEDURE

- **General** Soak in **HI7061** general cleaning solution for approximately 1 hour.

Removal of films, dirt or deposits on the membrane/junction:

- **Protein** Soak in Hanna Instruments **HI7073** protein cleaning solution for 15 minutes.
- **Inorganic** Soak in Hanna Instruments **HI7074** inorganic cleaning solution for 15 minutes.
- **Oil/grease** Rinse with Hanna Instruments **HI7077** oil & fat cleaning solution.

IMPORTANT: After performing any of the cleaning procedures, rinse the electrode thoroughly with distilled water, drain and refill the reference chamber with fresh electrolyte, (not necessary for gel-filled electrodes) and soak the electrode in **HI70300** storage solution for at least 1 hour before taking measurements.

TROUBLESHOOTING

Evaluate your electrode performance based on the following:

- **Noise** (readings fluctuate up and down) could be due to:
 - **Clogged/Dirty Junction:** refer to the above "Cleaning Procedure"
 - **Loss of shielding** due to low electrolyte level (in refillable electrodes only): refill with **HI7071** solution for single junction or **HI7082** for double junction electrodes
- **Dry Membrane/Junction:** soak in **HI70300** storage solution for at least 1 hour
- **Drifting:** soak the electrode tip in warm **HI7082** solution for one hour and rinse the tip with distilled water; refill with fresh electrolyte (**HI7071** for single junction and **HI7082** for double junction electrodes)
- **Low Slope:** refer to the above "Cleaning Procedure"
- **No Slope:** check the electrode for cracks in glass stem or bulb (replace the electrode if cracks are found)
- **Slow Response/Excessive Drift:** soak the tip in **HI7061** solution for 30 minutes, rinse thoroughly in distilled water and then follow the above "Cleaning Procedure"
- **For ORP Electrodes:** polish the metal tip with a light abrasive paper (pay attention not to scratch the surface) and rinse thoroughly with water.

SUGGESTED INSTALLATIONS

SHORT DISTANCE, INDOOR INSTALLATION

Due to the low current involved, a very high grade of insulation is required.

A dry environment is needed in order to obtain a insulation level not lower than 10^{12} ohm.

This type of connection is very delicate and requires constant attention to maintain proper operating conditions.

Conventional electrodes should be used in indoor applications only, with a cable not longer than 10 m (33').

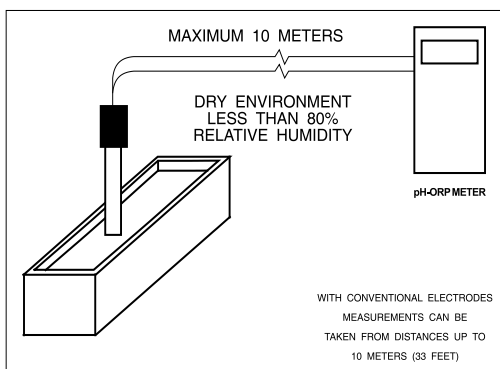

MEDIUM DISTANCE, INDOOR/OUTDOOR INSTALLATION

When an outdoor installation is required, to obtain accurate readings at distances from 10 to 50 m (33-165'), it is necessary to install a transmitter.

Since the introduction of AmpHel® electrodes, these distances are no longer a problem. You can now connect the meter directly to an AmpHel® electrode, saving the cost of a transmitter or expensive coaxial cable.

The standard cable length for AmpHel® electrodes is 5 m (16.5'). Additional lengths of regular cable up to 50 m (165'), can be installed without special connectors.

AmpHel® electrodes feature a built-in a micro-amplifier to boost the signal, drastically reducing susceptibility to noise and drift.

The sealed electrode body can stand a moisture up to 100% RH without any effect on the signal.

AmpHel® is a registered Trademark of "Hanna Instruments"

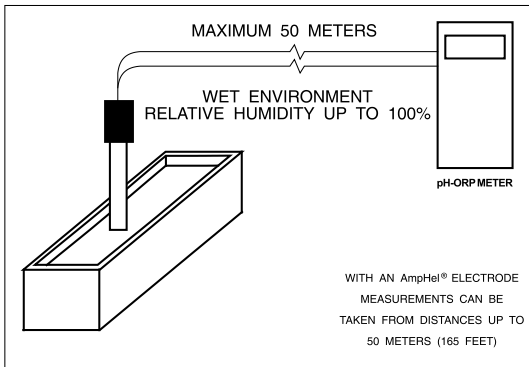

LONG DISTANCE INSTALLATIONS, ISOLATED OUTPUT FOR PC INTERFACE

If the needed installation distance is greater than 50 m (165'), it is necessary the use of a transmitter.

Hanna Instruments® offers a full line of pH and ORP transmitters with or without display.

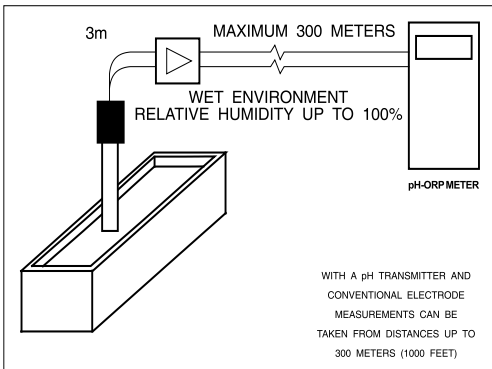

AmpHel® is a registered Trademark of "Hanna Instruments"

ACCESSORIES

pH CALIBRATION SOLUTIONS

HI7004M	pH4.01 buffer solution, 230 mL
HI7004L	pH4.01 buffer solution, 500 mL
HI7006M	pH6.86 buffer solution, 230 mL
HI7006L	pH6.86 buffer solution, 500 mL
HI7007M	pH7.01 buffer solution, 230 mL
HI7007L	pH7.01 buffer solution, 500 mL
HI7009M	pH9.18 buffer solution, 230 mL
HI7009L	pH9.18 buffer solution, 500 mL
HI7010M	pH10.01 buffer solution, 230 mL
HI7010L	pH10.01 buffer solution, 500 mL

ORP SOLUTIONS

HI7021M	ORP test solution 240 mV, 230 mL bottle
HI7021L	ORP test solution 240 mV, 500 mL bottle
HI7091M	Pre-treatment reducing solution, 230 mL bottle
HI7091L	Pre-treatment reducing solution, 500 mL bottle
HI7092M	Pre-treatment oxidizing solution, 230 mL bottle
HI7092L	Pre-treatment oxidizing solution, 500 mL bottle

ELECTRODE MAINTENANCE SOLUTIONS

HI70300M	Storage solution, 230 mL bottle
HI70300L	Storage solution, 500 mL bottle
HI7061M	General cleaning, 230 mL bottle
HI7061L	General cleaning, 500 mL bottle
HI7073M	Protein cleaning solution, 230 mL
HI7073L	Protein cleaning solution, 500 mL
HI7074M	Inorganic cleaning, 230 mL
HI7074L	Inorganic cleaning, 500 mL
HI7077M	Oil & fat cleaning, 230 mL
HI7077L	Oil & fat cleaning, 500 mL
HI7071	3.5M KCl + AgCl electrolyte solution (4 x 50 mL)
HI7072	1M KNO ₃ electrolyte (4 x 50 mL)
HI7082	3.5M KCl electrolyte solution (4 x 50 mL)

pH ELECTRODES

HI1090T Screwcap PG13.5 connector, double junction, glass body

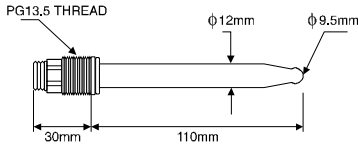

HI1110S Screw connector, single junction, glass body
HI1130B/3 BNC connector, 3 m (9.9') cable, single junction, glass body

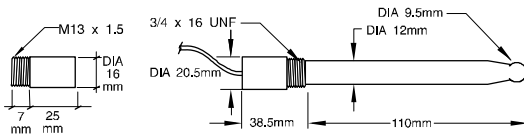

HI1110S

HI1130B/3

HI1110T Screwcap PG13.5 connector, double junction, glass body

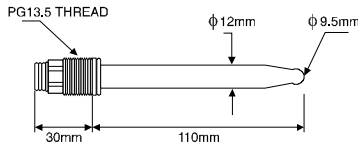

HI1114S Screw connector, double junction, plastic body
HI1134B/3 BNC connector, 3 m (9.9') cable, double junction plastic body

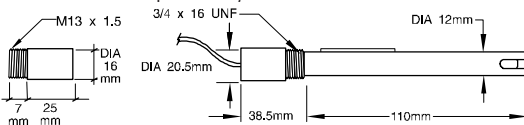

HI1114S

HI1134B/3

HI1115S Screw connector, single junction, glass body
HI1135B/3 BNC connector, 3 m (9.9') cable, single junction, glass body

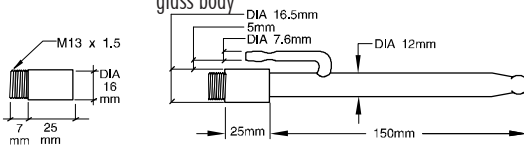

HI1115S

HI1135B/3

HI1210T Screwcap PG13.5 connector, double junction, plastic body

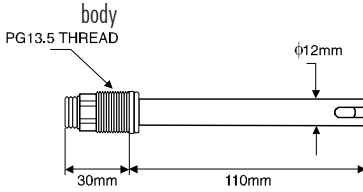

HI1910B BNC connector, 1 m (3.3') cable, double junction, plastic body, built-in amplifier

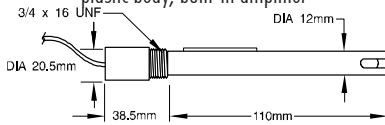

HI1911B BNC connector, 1 m (3.3') cable, double junction, plastic body, built-in amplifier

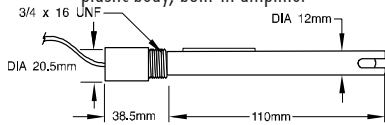

HI1912B BNC connector, 1 m (3.3') cable, double junction, plastic body, built-in amplifier

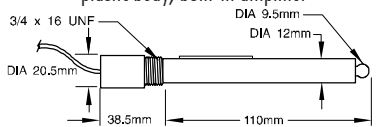

HI1912B/5 BNC connector, 5 m (16.5') cable, double junction, plastic body, built-in amplifier

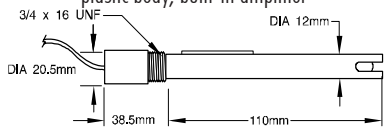

HI2114B/5 BNC connector, 5 m (16.5') cable, double junction, plastic body

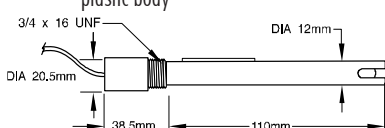

HI2910B/5 BNC connector, 5 m (16.5') cable, double junction, plastic body, built-in amplifier

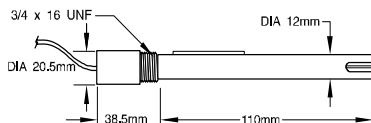

ORP ELECTRODES

HI2930B/5 BNC connector, 5 m (16.5') cable, Pt, plastic body, built-in amplifier

HI3110S Screw connector, Pt, glass body

HI3130B/3 BNC connector, 3 m (9.9') cable, Pt, glass body

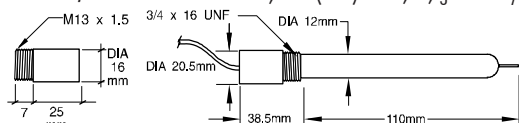

HI3110S

HI3130B/3

HI3110T Screwcap PG13.5 connector, Pt, glass body

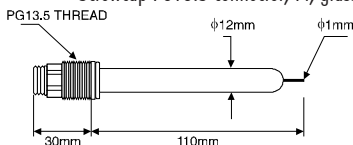

HI3115S Screw-type connector, side-arm, Pt, glass body

HI3135B/3 BNC connector, 3 m (9.9') cable, side-arm, Pt, glass body

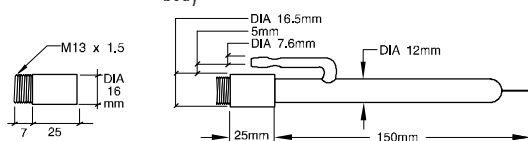

HI3115S

HI3135B/3

H 3210T Screwcap PG13.5 connector, Pt, plastic body

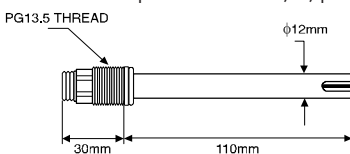

HI3410S Screw connector, Pt, plastic body

HI3430B/3 BNC connector, 3 m (9.9') cable, Pt, plastic body

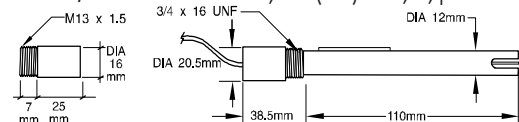

HI3410S

HI3430B/3

HI3932B/5 BNC connector, 5 m (16.5') cable, Pt, plastic body, built-in amplifier

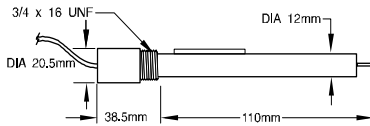

HI4110S Screw connector, Au, glass body
HI4130B/3 BNC connector, 3 m (9.9') cable, Au, glass body

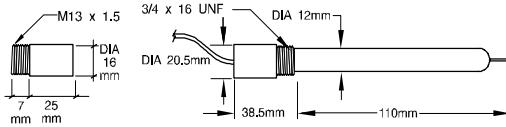

HI4110S

HI4130B/3

HI4932B/5 BNC connector, 5 m (16.5') cable, Au, plastic body, built-in amplifier

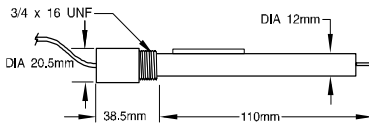

OTHER ACCESSORIES

- HI98501** *ChecktempC* thermometer with penetration probe and 0.1 °C resolution (-50.0 to 150.0 °C)
- HI8614** pH transmitter (0.00 to 14.00 pH range)
- HI8614L** pH transmitter with display (0.00 to 14.00 pH range)
- HI8614-01** pH transmitter (-2.00 to 16.00 pH range)
- HI8614L-01** pH transmitter with display (-2.00 to 16.00 pH range)
- HI8615** ORP transmitter (± 1000 mV range)
- HI8615L** ORP transmitter with display (± 1000 mV range)
- HI8615-01** ORP transmitter (± 1999 mV range)
- HI8615L-01** ORP transmitter with display (± 1999 mV range)
- BLPUMPS** Dosing pumps with flow rate from 1.5 to 20 lph
- HI7871 & HI7873** Level controllers
- HI6050 & HI6051** Submersible electrode holders
- HI6054 & HI6057** Electrode holders for in-line applications

All rights are reserved. Reproduction in whole or in part is prohibited without the written consent of the copyright owner.

HI778P	Coaxial cable and connectors for screw-type electrodes
HI8427	pH/ORP electrode simulator with 1 m (3.3') coaxial cable ending with female BNC connectors (HI7858/1)
HI931001	pH/ ORP electrode simulator with display and 1 m (3.3') coaxial cable ending with female BNC connectors (HI7858/1)

RECOMMENDATIONS FOR USERS

Before using these products, make sure they are entirely suitable for the environment in which they are used.

Operation of these instruments in residential areas could cause unacceptable interferences to radio and TV equipment, requiring the operator to follow all necessary steps to correct interferences.

The trimmers are sensitive to electrostatic discharges. It is recommended to use antistatic screwdrivers.

Any variation introduced by the user to the supplied equipment may degrade the instruments' EMC performance.

To avoid electrical shock, do not use these instruments when voltages at the measurement surface exceed 24 VAC or 60 VDC.

To avoid damage or burns, do not perform any measurement in microwave ovens.

Hanna Instruments reserves the right to modify the design, construction and appearance of its products without advance notice.



Hanna Instruments Inc.

Highland Industrial Park

584 Park East Drive

Woonsocket, RI 02895 USA

Technical Support for Customers

Tel. (800) 426 6287

Fax (401) 765 7575

E-mail tech@hannainst.com

www.hannainst.com