

Instruction Manual

HI88703 Turbidity Meter

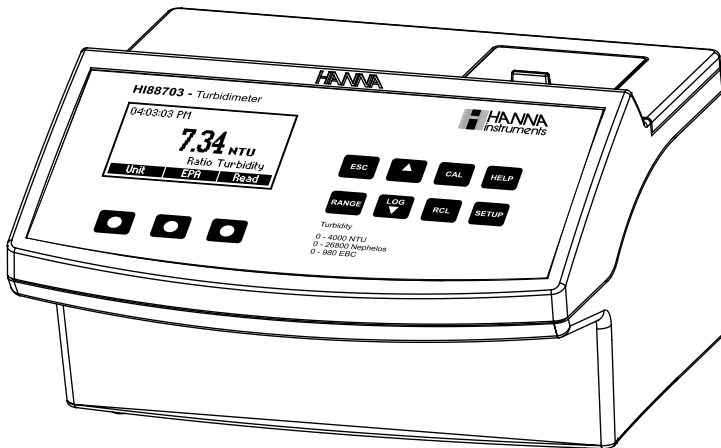

Dear Customer,

Thank you for choosing a Hanna Instruments product.

Please read this instruction manual carefully before using this instrument.

This manual will provide you with the necessary information for correct use of this instrument, as well as a precise idea of its versatility.

If you need additional technical information, do not hesitate to e-mail us at tech@hannainst.com or view our worldwide contact list at www.hannainst.com.

WARRANTY

HI88703 is guaranteed for two years against defects in workmanship and materials when used for its intended purpose and maintained according to instructions. This warranty is limited to repair or replacement free of charge.

Damage due to accidents, misuse, tampering or lack of prescribed maintenance is not covered.

If service is required, contact your local Hanna Instruments Office. If under warranty, report the model number, date of purchase, serial number and the nature of the problem. If the repair is not covered by the warranty, you will be notified of the charges incurred. If the instrument is to be returned to Hanna Instruments, first obtain a Returned Goods Authorization number from the Technical Service department and then send it with shipping costs prepaid. When shipping any instrument, make sure it is properly packed for complete protection.

To validate your warranty, fill out and return the enclosed warranty card within 14 days from the date of purchase.

CERTIFICATION

All Hanna Instruments conform to the **CE European Directives**.

Disposal of Electrical & Electronic Equipment. The product should not be treated as household waste. Instead hand it over to the appropriate collection point for the recycling of electrical and electronic equipment which will conserve natural resources.

Disposal of waste batteries. This product contains batteries, do not dispose of them with other household waste. Hand them over to the appropriate collection point for recycling.

Ensuring proper product and battery disposal prevents potential negative consequences for the environment and human health. For more information, contact your city, your local household waste disposal service, the place of purchase or go to www.hannainst.com.



All rights are reserved. Reproduction in whole or in part is prohibited without the written consent of the copyright owner, Hanna Instruments Inc., Woonsocket, Rhode Island, 02895, USA.

TABLE OF CONTENTS

WARRANTY	2
CERTIFICATION	2
PRELIMINARY EXAMINATION	4
GENERAL DESCRIPTION	4
ABBREVIATIONS	5
PRINCIPLE OF OPERATION	5
FUNCTIONAL DESCRIPTION	7
SPECIFICATIONS	9
GENERAL TIPS FOR AN ACCURATE MEASUREMENT	10
START UP	16
RANGE SELECTION	17
TUTORIAL MODE	17
HELP MODE	18
MEASUREMENT PROCEDURE FOR RATIO/NON RATIO TURBIDITY RANGE	18
CALIBRATION PROCEDURE FOR RATIO/NON RATIO TURBIDITY RANGE	21
GOOD LABORATORY PRACTICE (GLP)	26
RESTORE FACTORY CALIBRATION	26
LOG AND LOG RECALL	27
SETUP	28
LAMP REPLACEMENT	30
FUSE REPLACEMENT	31
PC INTERFACE	31
ACCESSORIES	31

PRELIMINARY EXAMINATION

Please examine this product carefully. Make sure that the instrument is not damaged. If any damage occurred during shipment, please contact your local Hanna Instruments Office.

Each **HI88703** Bench Turbidity instrument is supplied complete with:

- Five Sample Cuvettes and Caps
- Calibration Cuvettes for turbidimeter
- Silicone Oil
- Tissue for wiping the cuvettes
- Power cord
- Instruction Manual
- Instrument Quality Certificate

Note: Save all packing material until you are sure that the instrument functions correctly. Any defective item must be returned in its original packing with the supplied accessories.

GENERAL DESCRIPTION

HI88703 is a high accuracy, meter that benefits from Hanna Instruments' years of experience as manufacturer of analytical instruments.

The **HI88703** is especially designed for water quality measurements, providing reliable and accurate readings on low turbidity. The **HI88703** meets and exceeds the requirements of **USEPA** and **Standard Methods**.

The instrument is based on a state-of-the-art optical system which guarantees accurate results, assures long term stability and minimizes stray light and color interferences. It also compensates for variations in intensity of the lamp, making no need for frequent calibration.

The 25 mm round cuvettes made from special optical glass guarantee the repeatability and consistency of the measurements.

Turbidity measurements can be made in the 0.00 to 4000 NTU (Nephelometric Turbidity Units) range when ratio measurements are used and in the 0.00 to 40.0 NTU range when non ratio method is used. The instrument has an EPA compliance reading mode which rounds the reading to meet EPA reporting requirements. Alternative EBC and Nephelos measuring units are available.

Depending on the measured sample and needed accuracy, normal measurement, continuous measurement or signal averaging measurement can be selected.

A two, three, four or five-point calibration could be performed by using the supplied (<0.1, 15, 100, 750 and 2000 NTU) standards. When user prepared standards are used, the calibration points can be modified.

HI88703 has complete G.L.P. (Good Laboratory Practice) functions that allows traceability of the calibration conditions. The last calibration points, time and date can be checked.

HI88703 has a user-friendly interface with an easy to understand, graphical LCD. All messages are in plain text, easy to read and understand. Comprehensive contextual help is available at a simple key press. All messages and helps are available in several languages. Confirmation and error acoustic signals help the user during instrument operation. Furthermore, a tutorial mode of operation guides the user step by step through the analysis process.

The instrument's logging function offers complete information for the measurement. Up to 200 measurements can be stored in the internal memory and consulted at any time. In order to further store or analyse, the data can be downloaded to a PC using the USB port.

ABBREVIATIONS

NTU	Nephelometric Turbidity Units	RTC	Real Time Clock
JTU	Jackson Turbidity Units	RH	Relative Humidity
FTU	Formazin Turbidity Units	ID	Identification
USEPA	US Environmental Protection Agency	EBC	European Brewery Comitee
LCD	Liquid Crystal Display		

PRINCIPLE OF OPERATION

Turbidity is the optical property that causes light to be scattered and absorbed, rather than transmitted. The scattering of the light that passes through a liquid is primarily caused by the suspended solids. The higher the turbidity, the greater the amount of scattered light. Because even the molecules in a very pure fluid scatter light to a certain degree, no solution will have zero turbidity.

The **USEPA Method 180.1** specify the key parameters for the optical system to measure turbidity for drinking, saline and surface water in a 0 to 40 NTU range, using the nephelometric method.

The **HI 88703** instrument is designed to meet or exceed the criteria specified by the **USEPA Method 180.1** and **Standard Method 2130 B**.

The light beam that passes through the sample is scattered in all directions. The intensity and pattern of the scattered light is affected by many variables like wavelenght of the incident light, particle size and shape, refractive index and color.

The optical system includes a tungsten filament lamp, a scattered light detector (90°) and a transmitted light detector (180°).

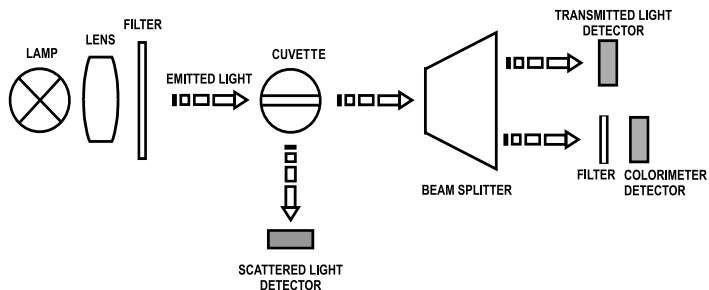

For the ratio turbidimeter range, the microprocessor of the instrument calculates the NTU value, from the signals that reaches the two detectors, by using an effective algorithm. This algorithm corrects and compensates for interferences of color, making the **HI88703** instrument color-compensated. The optical system and measuring technique compensate also for the lamp intensity fluctuations, minimizing the need of frequent calibration.

For the non ratio turbidimeter range, the NTU value is calculated from the signal on the scattered light detector (90°). The method offers a high linearity on the low range. The method is more sensitive to the lamp intensity fluctuations.

The lower detection limit of a turbidimeter is determined by the so called “stray light”. Stray light is the light detected by the sensors, that is not caused by light scattering from suspended particles.

The optical system of **HI88703** instrument is designed to have very low stray light, providing accurate results for low turbidity samples. However, special care must be taken when measuring low turbidities (see page 10 “General Tips for an Accurate Measurement” for sample preparation and measuring techniques).

MEASUREMENT UNITS

The most used units for turbidity are NTU (Nephelometric Turbidity Units). In the beer industry a common unit is EBC (European Brewery Comitee).

The **HI88703** turbidimeter reports the measurements in NTU, EBC or Nephelos. One NTU is equal with 0.245 EBC or 6.7 Nephelos.

Calibration and measurements are done only in NTU and the results in other units are obtained by multiplying with the respective factors.

FUNCTIONAL DESCRIPTION

INSTRUMENT DESCRIPTION

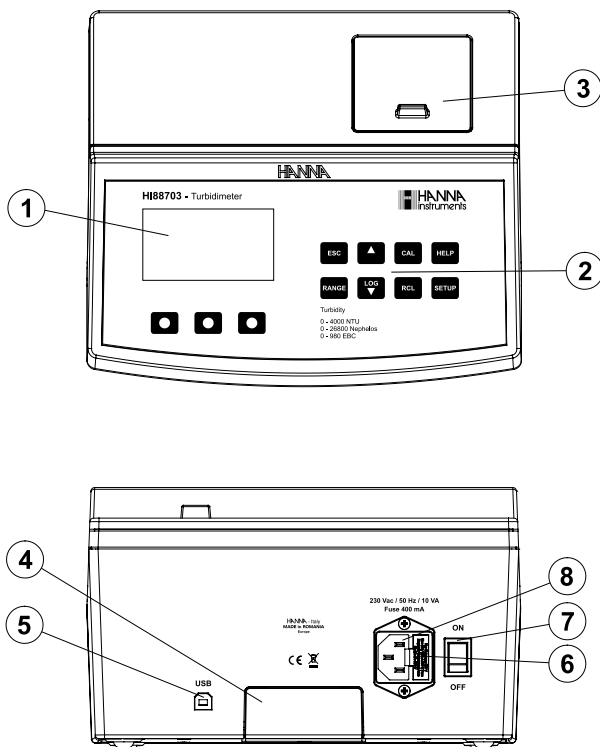

- 1) Liquid Crystal Display (LCD). The LCD has backlight for better visibility in dark environments.
- 2) Keypad. Splash proof resistant.
- 3) Cuvette Lid. Close the cuvette lid prior to start a measurement.
- 4) Lamp lid and the related fixing screw
- 5) USB connector
- 6) Fuse holder
- 7) Mains switch
- 8) Mains connector

DISPLAY DESCRIPTION



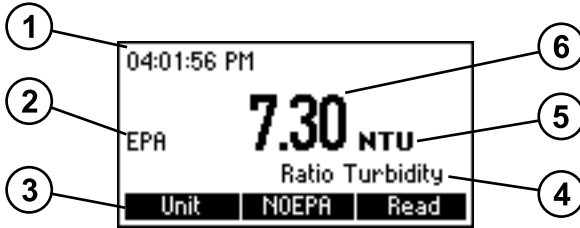





The display contains the following fields:



- 1) The current time in selected format
- 2) Information related to the measurement
- 3) Functional keys
- 4) Currently selected parameters
- 5) Measuring units
- 6) Measured value

KEYBOARD DESCRIPTION

The keyboard contains 8 direct keys and 3 functional keys with the following functions:

-  The function of each of the three functional keys depends on the name displayed on the LCD above them.
-  Press to return to the main screen.
-  When in the main screen, press to access the change parameter screen.
-  Press to move up in menu and help or to increment a set value.
-  Press to move down in menu and help or to decrement a set value. Press to log the current reading.
-  Press to access calibration menu.
-  Press to recall the log.
-  Press to display the help screen.
-  Press to access the setup menu.

SPECIFICATIONS

Range - non ratio mode	0.00 to 9.99; 10.0 to 40.0 NTU 0.0 to 99.9; 100 to 268 Nephelos 0.00 to 9.80 EBC
Resolution - non ratio mode	0.01; 0.1 NTU 0.1; 1 Nephelos 0.01 EBC
Range - ratio mode	0.00 to 9.99; 10.0 to 99.9; 100 to 4000 NTU 0.0 to 99.9; 100 to 26800 Nephelos 0.00 to 9.99; 10.0 to 99.9; 100 to 980 EBC
Resolution - ratio mode	0.01; 0.1; 1 NTU 0.1; 1 Nephelos 0.01; 0.1, 1 EBC
Range selection	Automatically
Accuracy	±2% of reading plus 0.02 NTU (0.15 Nephelos; 0.01 EBC) ±5% of reading above 1000 NTU (6700 Nephelos; 245 EBC)
Repeatability	±1% of reading or 0.02 NTU (0.15 Nephelos; 0.01 EBC) whichever is greater
Stray Light	< 0.02 NTU (0.15 Nephelos; 0.01 EBC)
Light Detector	Silicon Photocell
Method	Nephelometric method (90°) or Ratio Nephelometric Method (90° & 180°), Adaptation of the USEPA Method 180.1 and Standard Method 2130 B .
Measuring mode	Normal, Average, Continuous.
Turbidity Standards	<0.1, 15, 100, 750 and 2000 NTU
Calibration	Two, three, four or five-point calibration
Light Source	Tungsten filament lamp
Lamp life	greater than 100,000 readings
Display	40 x 70 mm graphic LCD (64 x 128 pixels) with backlight
LOG Memory	200 records
Serial Interface	USB
Environment	0 °C (32 °F) to 50 °C (122 °F); max 95% RH non-condensing
Power supply	230 V/50 Hz or 115 V/60 Hz 20 W
Dimensions	230 x 200 x 145 mm (9 x 7.9 x 5.7") L x W x H
Weight	2.5 Kg (88 oz.)

GENERAL TIPS FOR AN ACCURATE MEASUREMENT

HI88703 is a highly accurate meter for turbidity. To meet the instrument's performance and fully benefit of its features, it is very important for the analyst to use proper measurement techniques for accurate, precise and repeatable readings. Special care must be taken during sample preparation and handling. The instructions listed below should be carefully followed during measuring and calibration to ensure best accuracy.

GENERAL RULES

- Always put the instrument on a flat, rugged surface when taking measurements.
- Do not operate in direct sunlight.
- Keep the lid of the instrument closed when it is not used to prevent dust or dirt entering inside.
- Always close the lid of the instrument during measurement.
- Always use cuvettes without scratches or cracks because they can cause inaccurate readings.
- Always cap the cuvettes to avoid spillage of the sample into the instrument.
- Do not use too much oil to prevent contamination of the optical system.
- If possible use indexed and matched cuvettes.

CUVETTE

The cuvette is part of the optical system in all measurements. The light reaches the sample by passing through the cuvette glass. As a result, the measurement can be affected by the glass imperfections, dirt, dust, scratches, or fingerprints present on the cuvette surface. Special care must be taken in preparing and handling the cuvette.

Note: If you are using multiple cuvettes, always match the cuvettes.

CUVETTE HANDLING

The cuvettes should be free of scratches or cracks. Any cuvette with visible scratches will be discarded. The cuvettes should be periodically washed with acid. After washing, the cuvettes should be well rinsed multiple times with distilled or deionized water. Allow cuvettes to air-dry and store them for long periods of time with caps, to avoid dirt entering inside. Always handle the cuvette by touching only the cap or its top side (over the horizontal line).

Always store the cuvettes in separate boxes or with separators between them to avoid scratches on the surface.

CUVETTE PREPARATION

Whenever a cuvette is used, it must be clean inside and outside. When it is placed into the instrument, it must be dry outside, completely free of fingerprints or dirt.

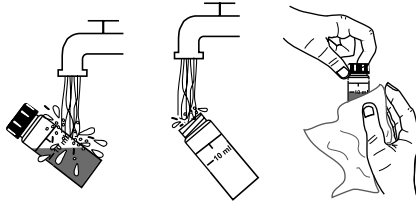

If the cuvette is not indexed, put the cuvette with the factory mark aligned with the sign on the instrument top.

CUVETTE OILING

To hide minor imperfections and scratches, the cuvettes should be oiled outside with the supplied silicone oil. This is very important, especially for low turbidity samples (< 1 NTU), otherwise scratches can contribute and alter turbidity readings.

The silicone oil has the same refractive index as the glass and will not alter the turbidity readings. It is important to apply only a thin layer of silicone oil.

Warning: Do not apply silicone oil in excess because it may retain dirt or contaminate the cuvette holder of the instrument, altering the turbidity readings.

It is very important to apply the silicone oil on a clean, dry cuvette. Apply a few drops of oil and wipe the cuvette thoroughly with a lint-free cloth. Wipe off the excess oil till you obtain a thin, uniform layer. If the procedure is correctly followed, the cuvette should appear nearly dry with no visible oil.

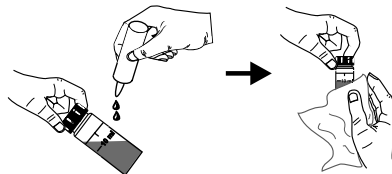

Note: The supplied cloth for oiling should be stored together with the silicone oil bottle and cuvettes, taking care to avoid contamination with dirt. After a few oiling procedures, the cloth will contain enough oil to wipe the bottle with it without adding more oil. From time to time add some drops of oil on the cuvette to provide the necessary oil quantity in the cloth.

INDEXING A CUVETTE

It is very important for low turbidity readings to always insert the cuvette into the instrument in the same position.

All cuvettes are factory indexed. This index can be used to put the cuvette with the factory mark on the cuvette aligned with the sign on the instrument top.

To further reduce the effect of glass imperfections, the cuvette can be indexed and use this new index as the position mark.

For indexing one cuvette or matching multiple cuvettes, the continuous reading mode is suggested. In this mode multiple successive readings are taken without turning off the lamp. The turbidity is immediately displayed, reducing considerably the measurement time.

Note: The instrument can not perform continuous readings if the average mode is on.

In order to index a cuvette follow the next steps:

- Fill the cuvette with high quality water (<math><0.1\text{ NTU}</math>) up to the 10 mL mark.

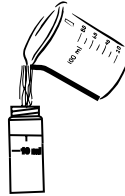

- Clean and oil the cuvette as described before.

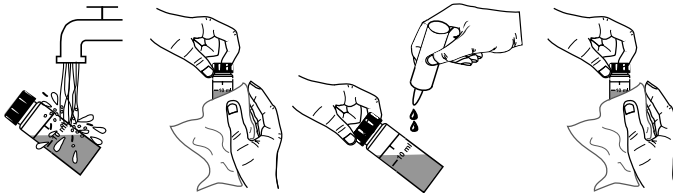

- Turn the instrument ON.

- Insert the cuvette into the instrument and press the **Read** key. Record the reading.

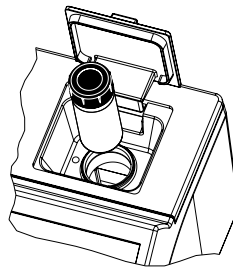

- Open the instrument lid, slightly rotate the cuvette and take a new reading.

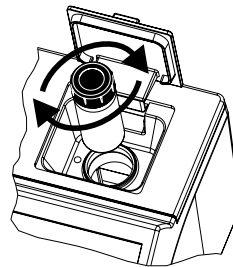

- Repeat the last step until you read the lowest NTU value.
- Alternatively, keep the **Read** key pressed to make continuous readings. After the first value is displayed, open the lid and start rotating the cuvette until the lowest NTU value is displayed.

- Mark this position on the thicker white band on the top of the cuvette with a water resistant pencil.
- Always use this position to align it with the sign on the instrument top.

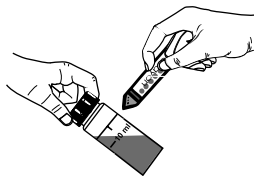

MATCHING MULTIPLE CUVETTES

Precise measurements require the use of a single cuvette. If it is not possible, cuvette selection and matching must be performed before taking measurements.

In order to match multiple cuvettes follow the next steps:

- Fill some cuvettes with high quality water (<math>< 0.1 \text{ NTU}</math>) up to the 10 mL mark.
- Clean and oil the cuvettes as described before.

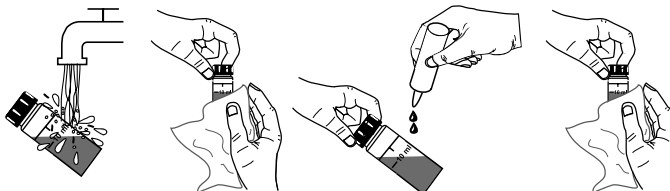
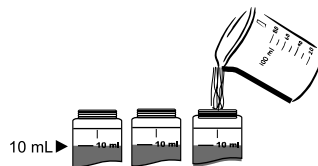

- Turn the instrument ON.
- Insert the first cuvette into the instrument and press the **Read** key. Record the reading.

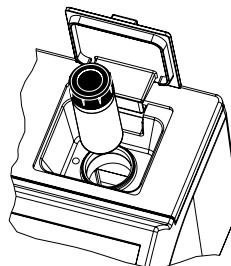

- Mark this position on the thicker white band on the top of the cuvette with a water resistant pencil.

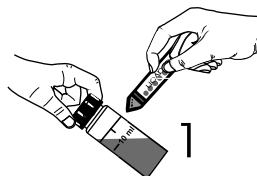

- Insert the second cuvette into the instrument and take a reading.
- Open the instrument lid, slightly rotate the cuvette and take a new reading.

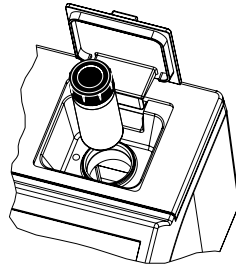

- Repeat the last step for the second cuvette until the reading is within 0.01 NTU of the value obtained for the first cuvette.
- Alternatively, keep the **Read** key pressed and, after the first value is displayed, open the lid and start rotating the cuvette until the read value matches the first cuvette.
- Mark this position on the second cuvette with a water resistant pencil.
- Follow the same procedure for all the cuvettes you need.

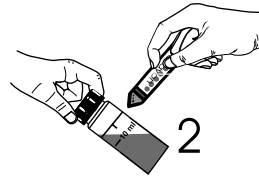

Note: If the cuvette is indexed, use the index to position it in the instrument.

SAMPLING TECHNIQUE

When taking turbidity measurements it is very important to select a representative sample. For consistent results, follow the next tips when sampling:

- Gently mix the water before taking the sample.
- If the sample is taken from a pipe, discard the first few liters.
- If measuring a non uniform source, collect samples from different places and mix them.

When measuring the collected sample, keep in mind the following:

- Samples should be analyzed immediately after collection because the turbidity can change in time.
- To avoid dilution of the sample it is better to rinse the cuvette with a quantity of sample and then discard. Only after this you can fill the cuvette with sample.
- Pay attention that cold samples do not condense on the sample cell.

REMOVING AIR BUBBLES (TURBIDITY only)

Any air bubbles present in the sample will cause high turbidity readings. To obtain accurate measurements, remove the air bubbles using one of these methods:

- Application of a partial vacuum;
- Addition of a surfactant, such as Triton X-100;
- Use of an ultrasonic bath;
- Heating the sample.

Sometimes it is necessary to combine two or more methods for efficient air bubble removal.

Note: Each method can alter the sample turbidity, if misused, so they have to be used with caution.

APPLICATION OF VACUUM

Vacuum works by decreasing the atmospheric pressure. In this way the bubbles from the solution come out to the surface. Application of vacuum is a very simple procedure and can be applied with any vacuum source at hand. The simplest equipment at hand is a syringe and a rubber stopper for vacuum degassing.

Notes:

- Pay attention that the vacuum equipment be clean and oil-free.
- It is not recommended to apply vacuum to a viscous sample that contains volatile components. In such cases the vacuum can determine the volatile component of the viscous sample to increase the bubbles from the sample.

ADDITION OF SURFACTANT

Surfactant addition works by changing the surface tension of the water. In this way bubbles are released from the sample. This method is effective in samples that are supersaturated with air.

The procedure consists in the addition of a drop of surfactant in the cuvette before adding the sample to be analyzed.

A convenient surfactant to use for degassing is Triton X-100.

Warning: Pay attention that changing the surface tension will cause a rapid settling of particles that cause turbidity. To avoid this problem, analyze as soon as possible the sample.

Do not shake vigorously the sample because the surfactant may foam. If you are using the same cuvette, rinse it before adding a new sample in order to avoid surfactant accumulation.

Surfactant contribution to the turbidity readings is negligible.

Note: Surfactant addition should be used for degassing only when other methods are ineffective.

USE OF AN ULTRASONIC BATH

The ultrasonic waves are very effective in removing air bubbles from samples. However, ultrasonic waves should be used with care because they can alter sample turbidity characteristics, by modifying the shape and size of particles which cause turbidity. The ultrasonic waves can also break the existing air bubbles, leading to a complication of the degassing process.

In order to avoid excess application of the ultrasonic waves you can apply ultrasound until all visible air bubbles are removed, and then measure the sample turbidity. This is the most used procedure for degassing.

If you are not sure that all air bubbles were removed, apply ultrasonic waves again for a short period of time and then measure the turbidity. Repeat this procedure until the turbidity is increasing instead of decreasing, sign that turbidity of the sample was altered.

In order to degas a sample fill a clean cuvette with sample and immerse it (1/2 to 2/3 immersed) in an ultrasonic bath. Follow the degassing procedure described above. Only after the degassing procedure is finished the cuvette can be capped.

HEATING THE SAMPLE

Use of heat to remove air bubbles, although very effective in some cases, should be handled with care because it can alter the turbidity of the sample. When heating a sample, the volatile components from the sample can vaporize, the suspended components can dissolve or the sample characteristics can change.

Therefore, the heating procedure should be used with extreme care.

The best way is to use a warm water bath and immerse the cuvette with sample into the bath. Heat the sample only until the visible bubbles are removed.

Note: Always cool the heated sample to the original sample temperature before measurement.

The heating procedure can be used in combination with vacuum or ultrasonic waves application for a more effective air bubble removal.

START UP

The **HI88703** Turbidity bench is supplied with all necessary accessories for making measurements. Unpack the instrument and place it on a flat surface. Do not place the instrument under direct sunlight. Connect the instrument to the mains with the provided power cord. Pay attention that the mains voltage match the value printed on the back of the instrument.

Switch on the instrument. On the LCD, the Hanna Instruments Logo will appear for a short time, followed by the main screen for ratio turbidity measurements.

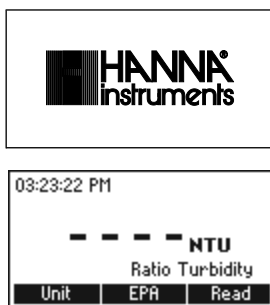

The instrument loads the selected language. If no language can be loaded the instrument will work in the “safe mode”. In “safe mode” all the messages are displayed in English and tutorial and help information are not available.

RANGE SELECTION

The **HI88703** instrument has two measuring ranges: Ratio Turbidity, Non Ratio Turbidity. When the instrument is in the main screen, the selected range is displayed in the right side of the LCD, on the message line.

To change the range, press the **RANGE** key.

When the display shows the Change parameter screen, press ▲ or ▼ keys until the new range is highlighted.

Press the **CFM** key to select the new range. The instrument returns to the main screen.

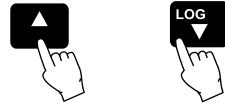
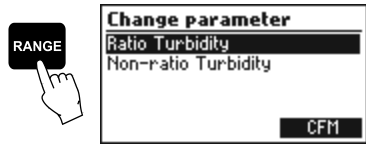

TUTORIAL MODE

The **HI88703** has a unique Tutorial Mode that provides additional information to help the inexperienced user during the measurements. The instruments display a screen, with explanations and confirmation button, each time when a preparation or other operation has to be performed by the operator. The instrument resumes the measuring sequence when the operator confirms that the requested operation was done.

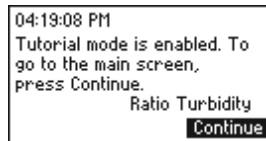

To disable this mode, when in the main screen, press the **SETUP** key to enter the setup, and then press ▼ key until the “Tutorial” line is highlighted. Press the **Disable** key and then press **ESC** to return to the main screen.

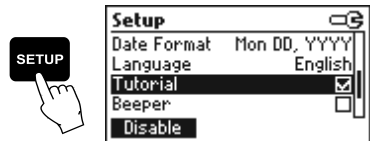

HELP MODE

The **HI88703** offers an interactive context help mode that assists the user at any moment.

To access help screens, just press **HELP**.

Depending which menu you are in, a screen with additional information will appear. To read all available data, scroll down or up the text using the **▲** or **▼** keys.

Press the **Support** key to access a page with Hanna Instruments support centers and their contact details.

Press the **Accessories** key to access a page with instrument accessories.

To exit support or accessories screens press **ESC** and the instrument will return to the previous help screen.

To exit help mode just press the **HELP** key again and the meter will display the previously selected screen.

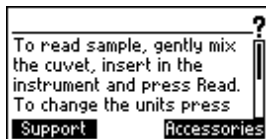

MEASUREMENT PROCEDURE FOR RATIO / NON RATIO TURBIDITY RANGE

When taking turbidity measurements, several basic rules should be followed:

- Always use cuvettes without scratches or cracks because they can cause inaccurate readings.
- Always cap the cuvettes to avoid spillage of the sample into the instrument.
- Always close the lid of the instrument during measurement.
- Do not use too much oil to prevent contamination of the optical system.

To take turbidity measurements, follow the next steps:

- Turn the instrument **ON** by pressing **ON/OFF**. When dashes are displayed on the LCD, the instrument is ready. The current time appears on the upper left corner of the display and the range name appears on the lower right corner.
- Fill a clean, dry cuvette with 10 mL of sample up to the mark, taking care to handle the cuvette by the top.
- Replace the cap.

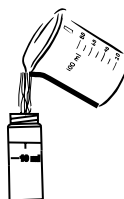
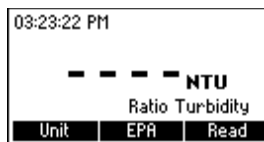

- Wipe the cuvette thoroughly with a lint-free cloth to remove any fingerprints, dirt or water spots.
- Apply silicone oil on the cuvette and wipe with a lint-free cloth to obtain an even film over the entire surface of the cuvette.

Note: It is very important to oil the cuvette, especially for low turbidity values (< 1 NTU) to hide the glass imperfections which can influence the reading.

- Place the cuvette into the instrument. Align the mark from the cuvette with the sign on the instrument top
- Close the lid.

Note: If you have a cuvette with indexing mark, place the cuvette into the instrument with the indexing mark aligned with the sign on the instrument top.

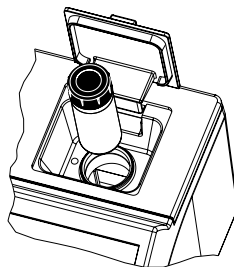
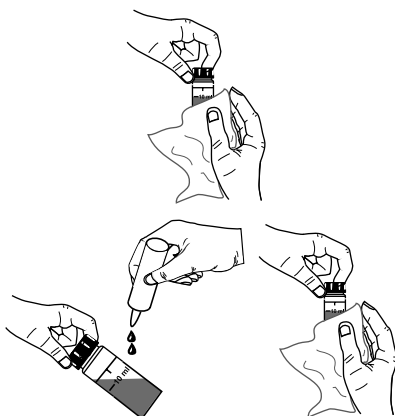

NORMAL MEASUREMENT

This type of measurement is best suited for regular readings, when the sample is stable and normal accuracy is required. In normal mode, the measurement takes about 10 seconds and the lamp is ON for a minimum period of time (about 7 seconds).

- Press the **Read** key to take the measurement. The display will show "READ" in the left side and blinking dashes. The dashes and lamp icon will appear during different measurement phases.
- The result is displayed in the selected units.

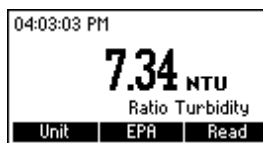
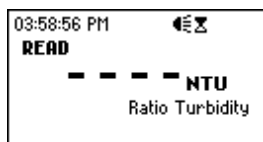

CONTINUOUS MEASUREMENT

This measurement mode is suitable when many measurements have to be taken in a short period of time. The mode is useful to evaluate a very fast settling sample. This measurement mode is recommended for indexing cuvettes.

- Press the **Read** key and keep it pressed to take continuous readings.

The display will show “**READ**” in the left side and blinking dashes. The dashes and lamp icon will appear during different measurement phases. The first value is displayed after 10 seconds and then a new reading is displayed each second as long as the **Read** key is kept pressed. When a new value is displayed, the measurement value will briefly blink.

The last value remains on the display after the **Read** key is released.

AVERAGED MEASUREMENT

This measurement mode is useful when samples that cause unstable readings are analyzed. By averaging several readings, noise effect is reduced and accurate measurements can be taken.

This mode can also be selected when high accuracy measurements are needed. In the average mode 10 measurements are averaged in a short period of time (about 20 seconds).

To use the averaged reading mode first enter setup and enable the Average reading mode. The “**AVG**” text will be displayed in the left side of the screen.

- Press the **Read** key to take the measurement.

The display will show “**READ**” in the left side and blinking dashes. The icon for lamp will appear during different measurement phases. The first value is displayed after 10 seconds and then a new average of the available readings is displayed each second. When a new value is displayed, the measurement value will blink briefly. The last averaged value remains on the display at the end of the measurement.

HI88703 automatically selects the correct turbidity range to display the results with the highest accuracy. If the measured value is higher than 4000 NTU (980 EBC or 26800 Nephelos), the display will show the maximum value blinking and the message “**Out of range**” on the message line.

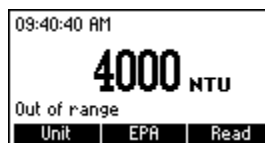
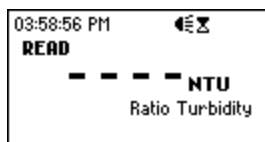
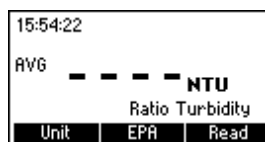

UNITS CHANGE

To change the units, simply press the **Unit** key when a measurement is available. The Nephelos value is obtained by multiply with 6.7 the NTU value. The EBC value is obtained by multiply with 0.245 the NTU value.

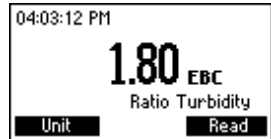
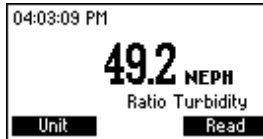
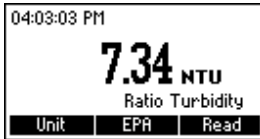

EPA MODE

To round the readings as EPA specifications press the **EPA** key. The “EPA” text is displayed on the left side of the LCD and the reading is rounded as follows:

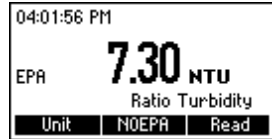

NTU	Round to Nearest
0.0-1.0	0.05
1-10	0.1
10-40	1
40-100	5
100-400	10
400-1000	50
>1000	100

CALIBRATION PROCEDURE FOR RATIO / NON RATIO TURBIDITY RANGE

H188703 has a powerful calibration function that compensates for lamp aging or changing. The calibration can be done using the supplied calibration solutions or user prepared standards. **H188703** turbidimeter is supplied with 5 AMCO standards: <0.1 NTU, 15 NTU, 100, 750 NTU and 2000 NTU. The Hanna Instruments standards are specially designed for this instrument. Turbidity standards have a shelf life and should not be used after the expiration date. Alternatively, formazin standards can be used. It is recommended that the turbidity value of the prepared calibration solutions to be close to the default calibration points.

The first calibration point should be near 0 NTU, the second point can be chosen between 10 and 20 NTU, the third point between 50 and 150 NTU, the fourth point between 600 and 900 NTU and the fifth point between 1500 and 2500 NTU.

FORMAZIN PREPARATION

In order to prepare formazin 4000 NTU stock solution, follow the next procedure:

Solution I : Dissolve 1.000 grams of hydrazine sulfate, $(\text{NH}_2)_2\text{H}_2\text{SO}_4$, in distilled, deionized water and dilute to 100 mL in a volumetric flask.

Warning: Handle hydrazine sulfate with care because it is a carcinogen reagent. Avoid inhalation, ingestion, or skin contact. Formazin solution can also contain some hydrazine traces.

Solution II : Dissolve 10.000 grams of hexamethylenetetramine, $(\text{CH}_2)_6\text{N}_4$, in distilled, deionized water and dilute to 100 mL in a volumetric flask.

Stock solution: Mix 10 mL Solution I and 10 mL Solution II in a flask. Let the stock solution stays 48 hours at $25 \pm 3 \text{ }^\circ\text{C}$ ($77 \pm 5 \text{ }^\circ\text{F}$). This will result in a 4000 NTU formazin suspension. It is very important for the formation of the formazin polymer to maintain the same temperature.

The stock solution (4000 NTU) can be stored up to one year in proper conditions. Store formazin in amber glass bottle or any UV-light blocking bottle.

To obtain a high quality formazin always use pure reagents and high-purity water.

To prepare the calibration standards, dilute the stock solution with the same high-purity water you used for the preparation of the stock solution. The diluted formazin solutions are not stable. They should be used immediately after preparation and discard immediately after use.

CALIBRATION

For best results, the measurement techniques must be followed during calibration. If formazin standards are used, mix the cuvettes gently for about 1 minute and then allow the standard to settle for 1 more minute before calibration.

Calibration can be performed in two, three four or five points. Calibration of the ratio turbidity range will not affect the non ratio turbidity range.

Before making the calibration, assure that you are on the correct range.

To enter calibration, press CAL key while in main screen. The first screen of GLP information is displayed. Press the Cal key to start calibration.

It is possible to interrupt calibration procedure at any time by pressing CAL CHECK key.



Calibration		
SN 83414xxxxxxx		
User Cal date&time:		
Feb 05,2007 03:49 PM		
Ratio Turbidity		
Cal	GLP	Delete

TWO-POINT CALIBRATION (Ratio and Non Ratio Turbidity)

- The first calibration point is displayed on the LCD as 0.00 NTU.

This point is used to check the quality of the water used for dilution and to confirm that the optical system is not dirty. If the value of the first point is over 0.15 NTU, a warning "Cal Point1 high !" is displayed when the calibration is saved and a warning "Out of calibration range" is displayed when measurements under 10.0 NTU are performed.

Calibration	
Point 1:	0.00 NTU
Ratio Turbidity	
Skip	Read

Note: The reading of the first point can be skipped by pressing the Skip key. In this case, the 0.00 NTU point will be used for calibration.

- Place the <0.1 NTU standard cuvette (or the cuvette with dilution water) into the holder and ensure that the cuvette mark is aligned with the sign on the instrument top.
- Close the lid and press the Read key. The display will show the value blinking and the lamp icon during measurement.

Note: If the Average mode was previously selected, the measurement in calibration mode will be done using the average.

- At the end of the measurement, the second proposed calibration point (15.0 NTU) is displayed.
- Remove the first standard cuvette.
- Place the 15 NTU standard cuvette (or the second formazyme prepared standard) into the holder, with the cuvette mark aligned with the sign on the instrument top.

Note: If necessary, press ▲ or ▼ key to edit each calibration point value to match the exact value of the standard as measured with a reference turbidimeter.

- Close the lid and press the Read key. The display will show the value blinking and the lamp icon during measurement.
- If Non ratio Turbidity range is selected, the display will briefly show "Store..." and the two point calibration is saved. The instrument returns in the main screen.
- If Ratio Turbidity range is selected, at the end of the measurement, the third proposed calibration point (100 NTU) is displayed.
- At this moment it is possible to exit calibration by pressing the End key.
- If the calibration is terminated, the display will briefly show "Store..." and the two point calibration is saved. The instrument returns in the main screen.

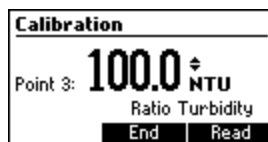
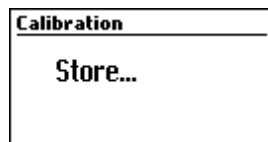
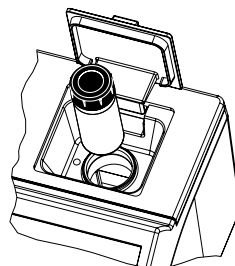
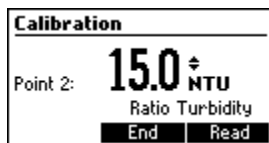
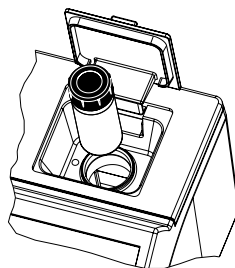

THREE-POINT CALIBRATION (Ratio Turbidity only)

To perform a three-point calibration, continue the procedure with the following steps:

- Remove the second standard cuvette.
- Place the 100 NTU standard cuvette (or the third prepared formazin standard) into the holder, with the cuvette mark aligned to the sign on the instrument top.
- Close the lid and press the Read key. The display will show the value blinking and the lamp icon during measurement.
- At the end of the measurement, the fourth proposed calibration point (750 NTU) is displayed.
- At this moment it is possible to exit calibration by pressing the End key.
- If the calibration is terminated, the display will briefly show "Store..." and the three point calibration is saved. The instrument returns in the main screen.

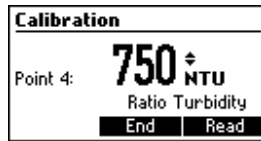
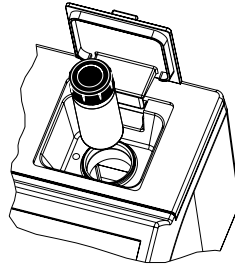

FOUR-POINT CALIBRATION (Ratio Turbidity only)

To perform a four-point calibration, continue the procedure with the following steps:

- Remove the third standard cuvette.
- Place the 750 NTU standard cuvette (or the fourth prepared formazin standard) into the holder, with the cuvette mark aligned to the sign on the instrument top.
- Close the lid and press the Read key. The display will show the value blinking and the lamp icon during measurement.
- At the end of the measurement, the fifth proposed calibration point (2000 NTU) is displayed.
- At this moment it is possible to exit calibration by pressing the End key.
- If the calibration is terminated, the display will briefly show "Store..." and the four point calibration is saved. The instrument returns in the main screen.

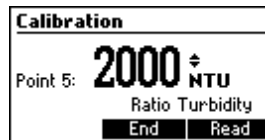
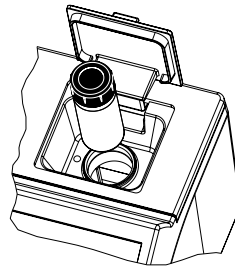

FIVE-POINT CALIBRATION (Ratio Turbidity only)

To perform a five-point calibration, continue the procedure with the following steps:

- Remove the fourth standard cuvette.
- Place the 2000 NTU standard cuvette (or the fourth prepared formazin standard) into the holder, with the cuvette mark aligned to the sign on the instrument top.
- Close the lid and press the Read key. The display will show the value blinking and the lamp icon during measurement.
- At the end of the measurement, the calibration is saved and the display will briefly show "Store...". The instrument returns in the main screen.

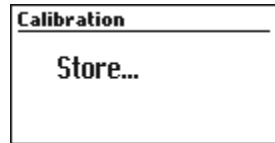
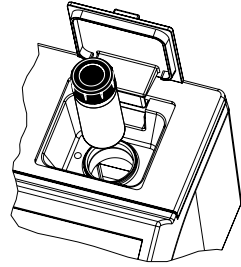

CALIBRATION ERROR MESSAGES

If the value of the standard read during the calibration is too far from the set value, the instrument will display a standard low or a standard high message.



Check if the correct standard is used or prepare a fresh standard, if formazine is used, and repeat the reading of the standard.

If the calculated calibration coefficients are outside a certain range a calibration error message is displayed.



OUT CAL RANGE FUNCTION

The instrument has a mechanism to prevent taking measurements in a range where the calibration does not assure the best results. The message "Out of Calibration Range" is displayed on the message line in the following situations:

- When the first calibration point is over 0.15 NTU and the reading is under 10 NTU.
- When two point calibration was performed and the reading value is over 40 NTU.
- When a three point calibration was performed and the reading is over 150% of the the third point value.
- When a four point calibration was performed and the reading is over 200% of the the fourth point value.

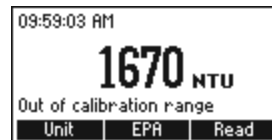

GOOD LABORATORY PRACTICE (GLP)

The **HI88703** has built in complete GLP information. The calibration date and the calibration points are displayed in a comprehensive mode for each range.

To display the GLP information, simply press CAL key. A screen with instrument serial number and with information about the calibration is displayed. For further information, press the GLP key.

The GLP contains:

- Instrument serial number
- The last user calibration date, in selected format and time in hh.mm format. If no calibration was performed, the "Factory Calibration" message is displayed.
- Parameter as Ratio Turbidity or Non Ratio Turbidity.
- The value of each calibration point (up to 5 points for ratio turbidimeter and 2 points for non ratio turbidimeter). If the first calibration point was skipped, the 0.00 value is displayed.

Calibration		
SN 88703xxxxxxx		
User Cal date&time:		
Feb 06,2007 08:45 AM		
Non-ratio Turbidity		
Cal	GLP	Delete

GLP	
CalPoint1:	0.00NTU
CalPoint2:	15.0NTU
CalPoint3:	100.0NTU
CalPoint4:	750NTU
Cal	Delete

RESTORE FACTORY CALIBRATION

To restore the factory calibration for the currently selected range, press **CAL** key when in the main screen. The first screen for the GLP is displayed. Press the **Delete** key to initiate the calibration delete procedure and then press the **CFM** key to delete the user calibration and restore the Factory calibration.

Note: Only the user calibration for the current selected range is deleted.

Calibration		
SN 88703xxxxxxx		
User Cal date&time:		
Feb 06,2007 08:45 AM		
Non-ratio Turbidity		
Cal	GLP	Delete

Calibration Delete	
Delete user calibration?	
Free Chlorine	CFM

LOG AND LOG RECALL

The **HI88703** has a powerful log function that could store up to 200 records.

Each record contains:

- the measuring range,
- the reading value,
- the measuring units,
- the date and time of the measurement,
- the current log number.

Notes: • The log can be saved only after a measurement is completed.

- A measurement can be saved only once.

LOG SAVE

To log a record, simply press LOG key after the measurement is completed. A record number is assigned to each logged measurement. Each reading can be stored only once.

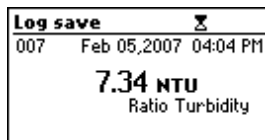

LOG RECALL

The log can be consulted at any time by simply pressing RCL key.

To exit log consulting, press RCL key again.

The log content is displayed one record at a time, starting with the most recent one. The information regarding one record is displayed in one screen.

To browse the log press the ▲ or ▼ keys.

LOG DELETE

The last log or all logs can be deleted.

To delete the last log, simply press the Delete key when the last log is displayed. The log will be deleted and the next log is immediately displayed.

To delete all logs, press the DelAll key. A confirmation screen is displayed. Press the CFM key to confirm the action. The log will be deleted and the instrument returns in the main screen.

Note: The records for all parameters are deleted when this action is performed.

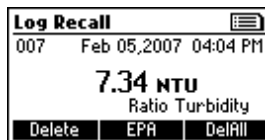

SETUP

In the Setup mode, the instrument's parameters, can be changed. Some parameters affect the measuring sequence and others are general parameters that change the behaviour or appearance of the instrument. The setup mode may be accessed from the main screen by pressing the SETUP key.



Press ESC or SETUP to return to the main screen.

A list of setup parameters will be displayed with currently configured setting. Press HELP for additional information.

Press the ARROW keys to select the parameter and depending to the parameter type, select the new value as follows.

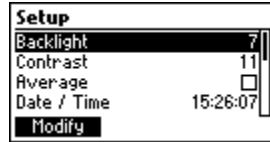

Backlight

Values: 0 to 8.

Press the Modify key to access the backlight value.

Use the ▲ or ▼ keys (alternatively, the ◀ ▶ functional keys) to increase or decrease the value.

Press the Accept key to confirm or ESC to return to the setup menu without saving the new value.

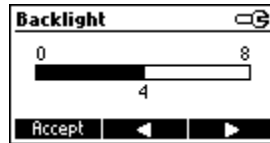

Contrast

Values: 0 to 20.

This option is used to set the display's contrast.

Press the Modify key to change the display's contrast.

Use the ▲ or ▼ keys (alternatively, the ◀ ▶ functional keys) to increase or decrease the value.

Press the Accept key to confirm the value or ESC to return to the setup menu without saving the new value.

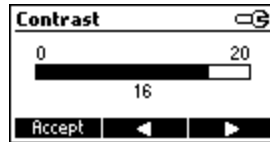

Average

Option: Enabled or Disabled.

This option is used to enable/disable averaged measuring mode. If enabled, the instrument takes 10 readings and display the resulting average value. The partial average is displayed during measurement. Press the functional key to enable or disable this option.



Date / Time

This option is used to set the instrument's date and time.

Press the Modify to change the date/time.

Press the ◀ ▶ functional keys to highlight the value to be modified (year, month, day, hour, minute or second). Use the ▲ or ▼ keys to change the value.

Press the Accept key to confirm or ESC to return to the setup without saving the new time or date .

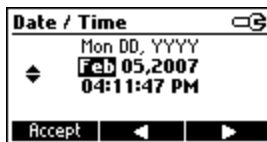

Time format

Option: AM/PM or 24 hours.

Press the functional key to select the new value.

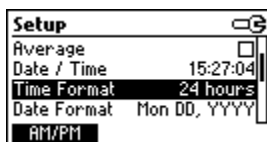

Date format

Press the Modify key to change the Date Format.

Use the ▲ or ▼ keys to select the desired format.

Press the Accept key to confirm or ESC to return to the setup menu without saving the new format.

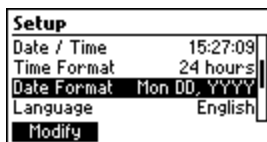

Language

Press the corresponding key to change the language. If the new selected language cannot be loaded, the previously selected language will be reloaded.

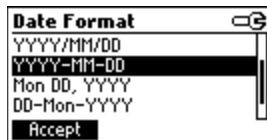

Tutorial

Option: Enabled or Disabled.

If enabled this option will provide the user short guides on the screen.

Press the functional key to enable/disable the tutorial mode.

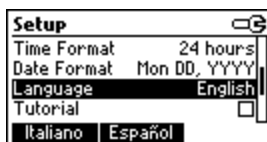

Beep On

Option: Enabled or Disabled.

When enabled, a short beep is heard every time a key is pressed.

A long beep alert sounds when the pressed key is not active or a error condition is detected.

Press the functional key to enable/disable the beeper.

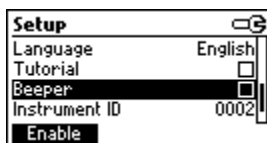
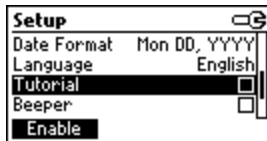

Instrument ID

Option: 0 to 9999.

This option is used to set the instrument's ID (identification number). The instrument ID is used while exchanging data with a PC.

Press the Modify key to access the instrument ID screen. Press the ▲ or ▼ keys in order to set the desired value. Press the Accept key to confirm the value or ESC to return to the setup menu without saving the new value.

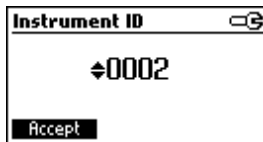

Meter information

Press the Select key to view the Instrument model, firmware version, language version and instrument serial number.

Press ESC to return to the Setup mode.



LAMP REPLACEMENT

The instrument tungsten lamp has a life longer than 100,000 measurements. In case of lamp failure, the defective lamp can be easily replaced. When the lamp is broken, the instrument displays a lamp error message.



To replace the lamp follow the next steps:

- Power off the instrument and take out the power cord.
- Remove the fixing screw of the lamp lid.
- Remove the lamp lid.
- Unscrew the lamp leads from connector.
- Unlock the lamp and extract it by pulling it out from the lamp holder handler.
- Place the new lamp in the right position and push it until it is securely locked.
- Insert the lamp leads into the connector and tight them using a screwdriver.
- Place back the lamp lid and secure with the screw.

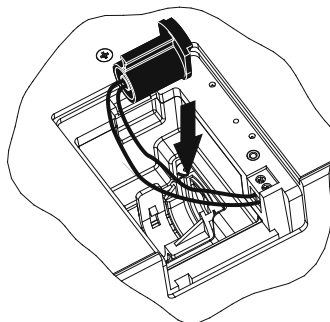

Warning: After lamp replacement the meter has to be recalibrated.

FUSE REPLACEMENT

To change the fuse follow next steps:

- Disconnect the power cord from the rear panel of the instrument.
- Pull out the fuse holder located near the power cord connector.
- Replace the fuse with a similar one.
- Push the fuse holder with the fuse in the appropriate place.

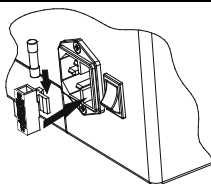

PC INTERFACE

Log data download from the instrument to the PC can be done with the **HI92000** Windows compatible software (optional). **HI92000** also offers graphing and on-line help features. Data can be exported to the most popular spreadsheet programs for further analysis.

To connect your instrument to a PC, use a standard USB cable. Make sure that your instrument is switched off. Plug one connector to the instrument's USB socket and the other to the USB port of your PC. Please refer to the **HI92000** software to download the data from the instrument.

To allow our users access to the latest version of Hanna Instruments PC compatible software, we made the products available for download at <http://software.hannainst.com>. Select the product code and click **Download Now**. After download is complete, use the **setup.exe** file to install the software.

ACCESSORIES

REAGENT SETS

- HI93703-58** Silicon oil (15 mL)
HI88703-11 Calibration set for turbidimeter(<0.1, 15, 100 750 and 2000 NTU)

OTHER ACCESSORIES

- HI731318** Tissue for wiping cuvettes (4 pcs.)
HI731331 Glass cuvettes (4 pcs.)
HI731335N Caps for cuvettes (4 pcs.)
HI740234 Replacement lamp for EPA turbidimeter (1 pcs.)
HI92000 Windows® compatible software
HI93703-50 Cuvettes cleaning solution (230 mL)

Recommendations for Users

Before using this meter, make sure it is entirely suitable for your specific application and for the environment in which it is used. Any variation introduced by the user to the supplied equipment may degrade the meter's performance. For yours and the meter's safety do not use or store the meter in hazardous environments.

Hanna Instruments reserves the right to modify the design, construction or appearance of its products without advance notice.

World Headquarters

Hanna Instruments Inc.

Highland Industrial Park

584 Park East Drive

Woonsocket, RI 02895 USA

www.hannainst.com