

BL100 • BL101

pH & ORP Pump Controllers



INSTRUCTION MANUAL

Dear
Customer,

Thank you for choosing a Hanna Instruments product.

Please read this instruction manual carefully before using this instrument.

This manual will provide you with the necessary information for correct use of this instrument, as well as a precise idea of its versatility.

If you need additional technical information, do not hesitate to e-mail us at tech@hannainst.com or view our contact list at www.hannainst.com.

All rights are reserved. Reproduction in whole or in part is prohibited without the written consent of the copyright owner, Hanna Instruments Inc., Woonsocket, Rhode Island, 02895, USA.

TABLE OF CONTENTS

1. PRELIMINARY EXAMINATION 4

2. SAFETY MEASURES 6

3. ABBREVIATIONS 6

4. SPECIFICATIONS 7

 4.1. BL100 pH CONTROLLER 7

 4.2. BL101 ORP CONTROLLER 8

 4.3. pH & ORP PROBE SPECIFICATIONS 9

5. DESCRIPTION 10

 5.1. GENERAL DESCRIPTION & INTENDED USE 10

 5.2. FUNCTIONAL & DISPLAY DESCRIPTION 12

6. INSTALLATION 17

7. SETUP 24

8. PUMP CONTROL 31

 8.1. AUTOMATIC CONTROL TYPES 31

 8.2. MANUAL CONTROL 32

9. EVENTS MANAGEMENT 33

 9.1. ALARMS 33

 9.2. WARNINGS 34

 9.3. SUMMARY OF GENERAL BEHAVIOR 34

10. CALIBRATION 35

 10.1. pH CALIBRATION (BL100 ONLY) 35

 10.2. ORP CALIBRATION (BL101 ONLY) 38

 10.3. pH & ORP CLEAR CALIBRATION 39

11. MEASUREMENT 40

12. ERROR MESSAGES 41

13. MAINTENANCE 42

 13.1. ELECTRODE CONDITIONING & MAINTENANCE 42

 13.2. PUMP TUBING REPLACEMENT 42

14. ACCESSORIES 44

CERTIFICATION 46

RECOMMENDATIONS FOR USERS 46

WARRANTY 46

1. PRELIMINARY EXAMINATION

Remove the instrument and accessories from the packaging and examine it carefully. For further assistance, please contact your local Hanna Instruments Office or email us at tech@hannainst.com.

Each instrument is delivered in a cardboard box.

pH model	Supplied with
BL100-00, without mounting kit	<ul style="list-style-type: none"> • HI10053 pH/temperature probe • 4.01 pH Buffer solution, 20 mL (3 pcs.) • 7.01 pH Buffer solution, 20 mL (3 pcs.) • Power connection cable • Instrument & electrode quality certificates • Instruction manual
BL100-10, with in-line mounting kit	<ul style="list-style-type: none"> • HI10053 pH/temperature probe • Pool controller aspiration filter • Pool controller injector, 1/2" thread • Saddle for Ø 50 mm pipe (2 pcs.) • PVC aspiration tubing (flexible) (5 m) • PE rigid dispensing tubing (for pump to injector) (5 m) • 4.01 pH Buffer solution, 20 mL (3 pcs.) • 7.01 pH Buffer solution, 20 mL (3 pcs.) • Power connection cable • Instrument & electrode quality certificates • Instruction manual
BL100-20, with flow cell mounting kit	<ul style="list-style-type: none"> • HI10053 pH/temperature probe • Flow cell for BL100/BL101 • Mounting panel assembly for BL100/BL101 • Pool controller aspiration filter • Pool controller injector, 1/2" thread • Saddle for Ø 50 mm pipe (3 pcs.) • PVC aspiration tubing (flexible) (5 m) • PE rigid dispensing tubing (for pump to injector) (15 m) • Barbed tubing adapter (1/2" to 6mm) (2 pcs.) • Flow cell valve (2 pcs.) • 4.01 pH Buffer solution, 20 mL (3 pcs.) • 7.01 pH Buffer solution, 20 mL (3 pcs.) • Power connection cable • Instrument & electrode quality certificates • Instruction manual

ORP model	Supplied with
BL101-00, without mounting kit	<ul style="list-style-type: none"> • HI20083 ORP/temperature probe • ORP test solution (3 pcs.) • Power connection cable • Instruction manual • Instrument & electrode quality certificates
BL101-10, with in-line mounting kit	<ul style="list-style-type: none"> • HI20083 ORP/temperature probe • Pool controller aspiration filter • Pool controller injector, 1/2" thread • Saddle for Ø 50 mm pipe (2 pcs.) • PVC aspiration tubing (flexible) (5 m) • PE rigid dispensing tubing (for pump to injector) (5 m) • ORP test solution (3 pcs.) • Power connection cable • Instrument & electrode quality certificates • Instruction manual
BL101-20, with flow cell mounting kit	<ul style="list-style-type: none"> • HI20083 ORP/temperature probe • Flow cell for BL100/BL101 • Mounting panel assembly for BL100/BL101 • Pool controller aspiration filter • Pool controller injector, 1/2" thread • Saddle for Ø 50 mm pipe (3 pcs.) • PVC aspiration tubing (flexible) (5 m) • PE rigid dispensing tubing (for pump to injector) (15 m) • Barbed tubing adapter (1/2" to 6mm) (2 pcs.) • Flow cell valve (2 pcs.) • ORP test solution (3 pcs.) • Power connection cable • Instrument & electrode quality certificates • Instruction manual

Note: Save all packing material until you are sure that the instrument works correctly. Any damaged or defective item must be returned in its original packing material with the supplied accessories.

2. SAFETY MEASURES



- Do not use chlorine tablets, granular chlorine or other non-liquid chlorine applications.
- Do not use the pump controller in a pool utilizing electrolytic chlorine generation (salt electrolysis).
- Do not add stabilizer (e.g. cyanuric acid) to the swimming pool while using the pump controller. To remove stabilizer from the pool, the pool must be drained and cleaned.



- Always disconnect the pump controller from power when making electrical connections.
- Do not run other cables with the power cabling.



- Do not touch the metallic part. Hot surface.

3. ABBREVIATIONS

FDA	Food and Drug Administration
LED	Light Emitting Diode
ORP	Oxidation-Reduction Potential
PE	Polyethylene
PVC	Polyvinyl Chloride
REDOX	Reduction & Oxidation
SPDT	Single Pole Double Throw

4. SPECIFICATIONS

4.1. BL100 pH CONTROLLER

Range	0.00 to 14.00 pH * -5.0 to 105.0 °C (23.0 to 221.0 °F)*
Resolution	0.01 pH 0.1 °C (0.1 °F)
Accuracy @ 25 °C / 77 °F	±0.10 pH ±0.5 °C (±0.9 °F)
Calibration	<ul style="list-style-type: none"> • User calibration: automatic, one or two-point with buffer solution (4.01, 7.01, 10.01 pH) • Process calibration: single point, adjustable (±0.50 pH around measured pH)
Temperature Compensation	Automatic
High or Low Mode Operation	<ul style="list-style-type: none"> • On/Off control using adjustable set point (6.00 to 8.00 pH) with adjustable hysteresis (0.10 to 1.00 pH) • Proportional control using adjustable set point (6.00 to 8.00 pH) with adjustable proportional band (0.10 to 2.00 pH)
Pump Control	<ul style="list-style-type: none"> • Startup delay timer at power-on (0 to 600 sec.) • Pump flow control 0.5 to 3.5 Liter/hour (0.13 to 0.92 Gallon/hour) and maximum output pressure 1 atm (14 psi) • Manual control for pump priming (defined in setup)
pH Alarms	<ul style="list-style-type: none"> • High & Low with enable or disable option • Triggered after 5 sec. if the controller records a set of consecutive readings over or under threshold values • Level with enable or disable option • Overtime protection (1 to 180 min. or Off)
Controller Alarm System	<ul style="list-style-type: none"> • Intuitive alarm system, using red, light-green and green color coded backlight • User-selectable, alarm setup options
Alarm Relay Output	<ul style="list-style-type: none"> • SPDT 2.5A / 230 Vac • Activated by pH-selectable alarm conditions
Probe Input	<ul style="list-style-type: none"> • Quick connect DIN connector • Galvanic isolation
Digital Input	<ul style="list-style-type: none"> • External switches can be attached to hold the control due to external events (low reagent level, recirculation pump doesn't work) • Galvanic isolation
Power Supply	100 - 240 Vac, 50/60 Hz
Power Consumption	15 VA

Environment	0 to 50 °C (32 to 122 °F), max. 95% RH non-condensing
Dimensions	90 x 142 x 80 mm (3.5 x 5.6 x 1.8")
Weight	910 g (32 oz)
Casing	Wall mounted, built-in pump, IP65 rated

* The range may be limited by the probe's limits.

4.2. BL101 ORP CONTROLLER

Range	-2000 to 2000 mV -5.0 to 105.0 °C (23.0 to 221.0 °F)*
Resolution	1 mV 0.1 °C (0.1 °F)
Accuracy @ 25 °C / 77 °F	± 5 mV ± 0.5 °C (± 0.9 °F)
Calibration	Process calibration: one-point, adjustable (± 50 mV around measured ORP)
High or Low Mode Operation	<ul style="list-style-type: none"> • On/Off control using adjustable set point (200 to 900 mV) with adjustable hysteresis (10 to 100 mV) • Proportional control using adjustable set point (200 to 900 mV) with adjustable proportional band (10 to 200 mV) • Startup delay timer at power-on (0 to 600 sec.)
Pump Control	<ul style="list-style-type: none"> • Pump flow control 0.5 to 3.5 Liter/hour (0.13 to 0.92 Gallon/hour) and maximum output pressure 1 atm (14 psi) • Manual control for pump priming (defined in setup)
ORP Alarms	<ul style="list-style-type: none"> • High & Low with enable or disable option • Triggered after 5 sec. if the controller records a set of consecutive readings over or under threshold values • Level with enable or disable option • Overtime protection (1 to 180 min. or Off)
Controller Alarm System	<ul style="list-style-type: none"> • Intuitive alarm system, using red, light-green and green color-coded backlight • User-selectable, alarm setup options
Alarm Relay Output	<ul style="list-style-type: none"> • SPDT 2.5A / 230 Vac • Activated by ORP selectable alarm conditions
Probe Input	<ul style="list-style-type: none"> • Quick connect DIN connector • Galvanic isolation

Digital Input	<ul style="list-style-type: none"> External switches can be attached to hold the control due to external events (low reagent level, recirculation pump doesn't work) Galvanic isolation
Power Supply	100 - 240 Vac, 50/60 Hz
Power Consumption	15 VA
Environment	0 to 50 °C (32 to 122 °F), max. 95% RH non-condensing
Dimensions	90 x 142 x 80 mm (3.5 x 5.6 x 1.8")
Weight	910 g (32 oz)
Casing	Wall mounted, built-in pump, IP65 rated

* The range may be limited by the probe's limits.

4.3. pH & ORP PROBE SPECIFICATIONS

Specifications	HI10053 (BL100)	HI20083 (BL101)
Range	0 to 12 pH	±2000 mV
Reference	Double junction	Double junction
Junction	Cloth	Cloth
Temperature sensor	Yes	Yes
Temperature range	-5 to 70 °C (23 to 158 °F)	-5 to 70 °C (23 to 158 °F)
AmpHel [®]	Yes	Yes
Matching pin	Yes	Yes
Body	PVDF (blue)	PVDF (red)
Top thread	3/4" NPT	3/4" NPT
In-line mounting thread	1/2" NPT	1/2" NPT
Cable length	2 m	2 m
Connector	Quick connect DIN connector	Quick connect DIN connector
Maximum pressure @25 °C	3 bar (43.5 psi)	3 bar (43.5 psi)

5. DESCRIPTION

5.1. GENERAL DESCRIPTION & INTENDED USE

BL100 & BL101 pump controllers are part of Hanna Instruments pool-line family and feature a single peristaltic dosing pump and a process electrode.

The BL100 accepts HI10053 pH probes. The BL101 accepts HI20083 ORP probes. These probes are manufactured by Hanna Instruments specifically for these controllers.

The probes are easily installed using 1/2" NPT threads for in-line or flow cell installation.

The electrodes have a matching pin that prevents ground loop effects from causing erratic readings and damage to the system.

Main Features

- Built-in peristaltic pump with On/Off or Proportional control
- Manual control for pump priming
- Overfeed protection using overtime safety timer
- Resumes dosing on restart in case of power failure
- Easy to read LCD display with intuitive, color-coded backlight
- Level input to stop control without reagents
- Probe detection and recognition
- User selectable languages (English, Spanish, French, Portuguese, Dutch, German)
- Specially designed to detect a broken pH electrode, based on a shifted ISO potential value
- Easy to navigate menu to program and adjust settings
- Wall-mounted design
- IP65-rated casing

Main Benefits

- Reduced installation time and costs
- Accessible and easy to maintain feeding system

The **BL100** measures the pH of a pool and offers automatic pH level control by adjusting the chemical dosing.

The **BL101** measures the chlorine level of a pool and offers automatic ORP level control by adjusting the chemical dosing.

BL100 and **BL101** can work together, stabilizing first the pH value and later the ORP value in the pool.

Each controller type works with one parameter only. If a wrong probe is used (e.g. **HI20083** for **BL100**), the controller signals the error by displaying "WRONG PROBE" message.

The chlorine level is measured based on the ORP or REDOX principle. An increase in the ORP value correlates with an increase in the free-chlorine level.

pH and disinfectant testing are made together for efficient disinfection and control. The efficacy of sanitizers, such as chlorine, is dependent on a controlled pH value. The ORP value is the most consistent indicator of the sanitizing effectiveness of the pool. Typically, 650-750 mV at 7.2 pH indicates proper water treatment.

Based on individual requirements, users can define the ideal set point for pH (e.g. 7.2 pH for **BL100**) and ORP (e.g. 700 mV for **BL101**).

The **BL100** model doses acid if water pH is above the assigned pH set point; and the **BL101** model doses hypochlorite if the ORP value is lower than the ORP set point.

The pump controller is an automatic system but it's advisable that users check the controller and verify pH and free-chlorine levels (in mg/L or ppm) in the pool using a portable colorimeter.

The pump controller should only be used in combination with liquid acid (e.g. sulfuric acid) and liquid chlorine (e.g. sodium hypochlorite).

5.2. FUNCTIONAL & DISPLAY DESCRIPTION

BL100 Front Panel

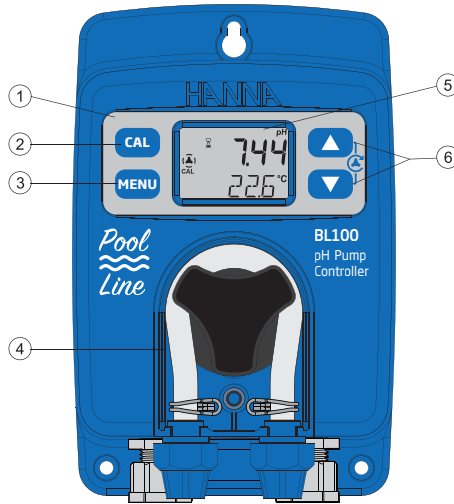

1. Keypad area
2. CAL key – Press calibration key to enter calibration mode.
3. MENU key – Press menu key to enter setup mode and move through the menu. A long press of this key is used to exit the menu and return to measurement.
4. Acid (or base) dosing pump
5. LCD display
6. Arrow keys – When in measurement mode, press the two arrow keys together to prime the pump.
 - When in menu mode, adjust settings.
 - When in menu mode, in Control screen, press the arrow keys together and a 10 seconds pump test will start.

BL100 Liquid Crystal Display (LCD)

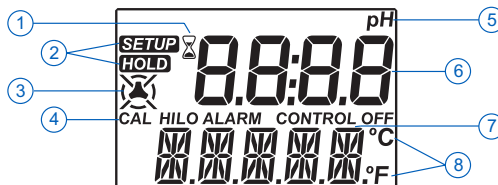

- | | |
|---|--|
| <ol style="list-style-type: none"> 1. Stability indicator 2. Mode tags 3. Dosing pump icon 4. Status indicators | <ol style="list-style-type: none"> 5. Measurement unit 6. First LCD line, measurement line 7. Second LCD line, temperature and message area 8. Temperature units |
|---|--|

BL101 Front Panel

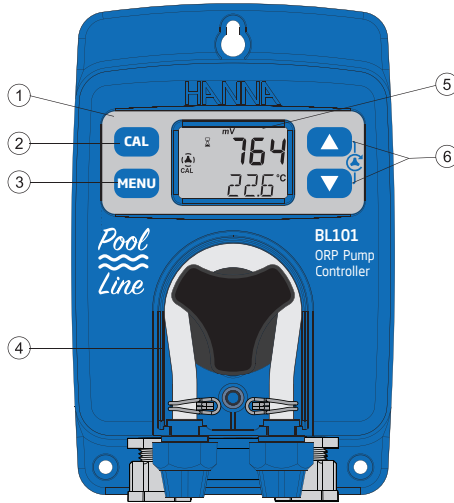

1. Keypad area
2. CAL key – Press calibration key to enter calibration mode.
3. MENU key– Press menu key to enter setup mode and move through the menu. A long press of this key is used to exit the menu and return to measurement.
4. Chlorine dosing pump
5. LCD display
6. Arrow keys – When in measurement mode, press the two arrow keys together to prime the pump.
 - When in menu mode, adjust settings.
 - When in menu mode, in Control screen, press the arrow keys together and a 10 seconds pump test will start.

BL101 Liquid Crystal Display (LCD)

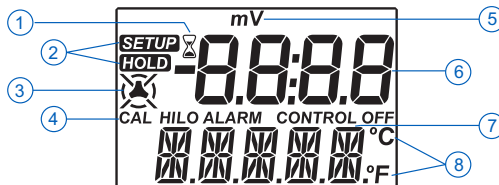

1. Stability indicator
2. Mode tags
3. Dosing pump icon
4. Status indicators
5. Measurement unit
6. First LCD line, measurement line
7. Second LCD line, temperature and message area
8. Temperature units

Rear Panel & Internal View

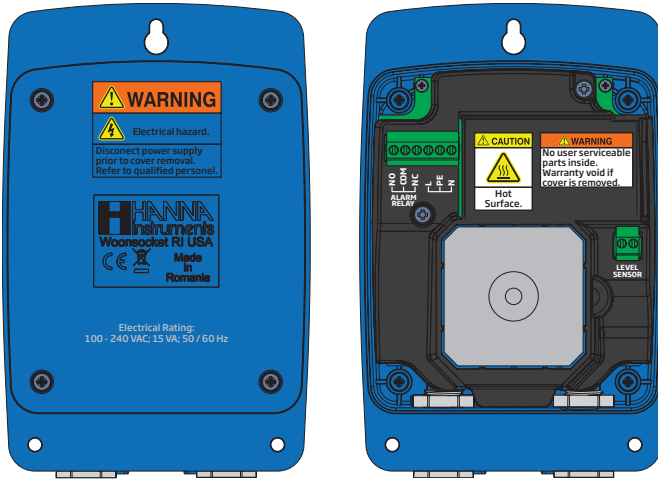

Use a Phillips head screwdriver and remove the four screws, pull back the cover and remove it.

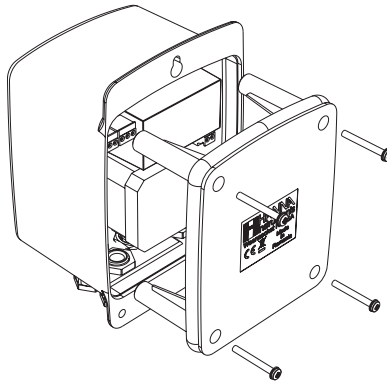

To replace the rear panel, insert the four legs back in place and tighten the four screws that secure the panel to the enclosure.

Alarm Relay, Power & Level Input

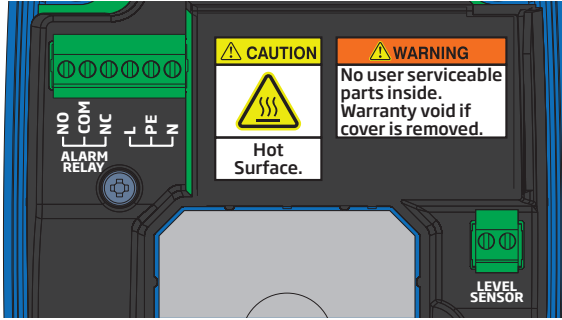

ALARM RELAY OUTPUT SPDT 2.5 A / 230 Vac	NO	Normally Open
	COM	Common
	NC	Normally Closed
	Pump controller not powered or Alarm condition	
	Working condition with no alarm	
POWER INPUT	L	Line
	PE	Protective Earth
	N	Neutral
LEVEL SENSOR		

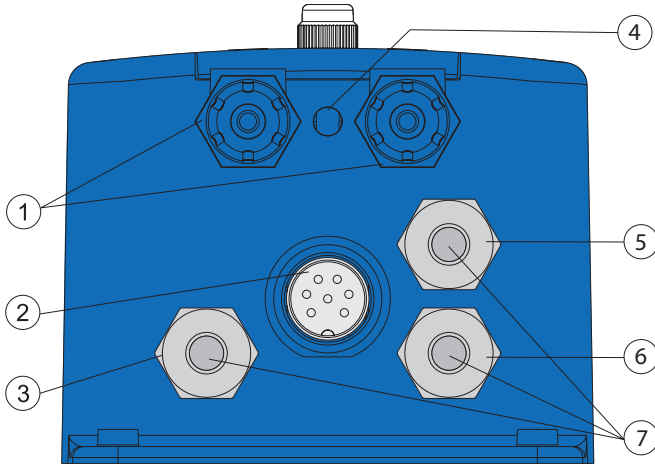

Position	Description
1	Tubing fittings
2	Sensor input
3	Cable gland for level input
4	Drainage opening
5	Cable gland for alarm relay
6	Cable gland for power cable
7	Enclosure cap

Cabling safety measures



- Always disconnect the pump controller from power when making electrical connections. To run the cabling through, unscrew the cable gland and remove the enclosure cap.
- Do not run other cables with the power cabling.
- Always run all cables through cable glands to maintain IP65 ratings.

6. INSTALLATION

General Guidelines

- Select controller location so that it is shielded from direct sunlight, dripping water and excess vibrations.
- Keep flow rate as constant as possible for optimum sensor operation.
- Install cable gland fittings and plugs as needed, to properly seal the pump controller.
- The probes are easily installed using 1/2" NPT threads for in-line or flow cell installation.
- For optimal operation, all tubing, cables, saddles and fittings must be properly connected.

Note: *BL100 and BL101 pump controllers are shipped with two types of tubing, for both flow cell and in-line configurations:*

- *rigid tubing for outlet (dispensing) - connects the pump output to the injector*
- *flexible tubing for inlet (aspiration) - connects the filter to the pump inlet*

Installation Steps

1. Check the tank level.
2. Calibrate the probe before use in the system.
3. Mount the probe into saddle or into a flow cell.
4. Connect the aspiration tubing between the chemical tank and the pump's inlet.
5. Connect the dispensing tubing between the pump and injector.
6. Check the level sensor's functionality (if used).

Installation Schemes

We are proposing a few typical installation schemes: in-line and flow cell.

In-Line Installation, Overview & Parts Table

A detailed representation of an in-line installation with relevant components is found below.

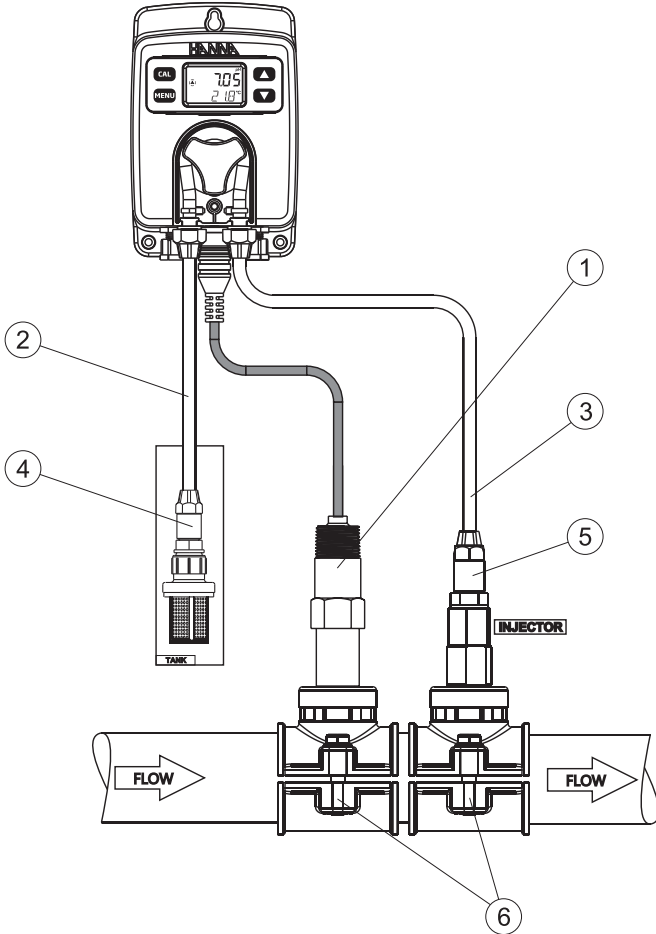

Position	Description
1	Electrode
2	Flexible PVC tubing
3	Rigid PE tubing
4	Aspiration filter
5	Injector, 1/2" thread
6	Saddle for Ø 50 mm pipe, using 1/2" thread

Flow Cell Installation, Overview & Parts Table

A detailed representation of a flow cell installation with relevant components is found below. The maximum pressure of the flow cell system is 3 atm (44 psi).

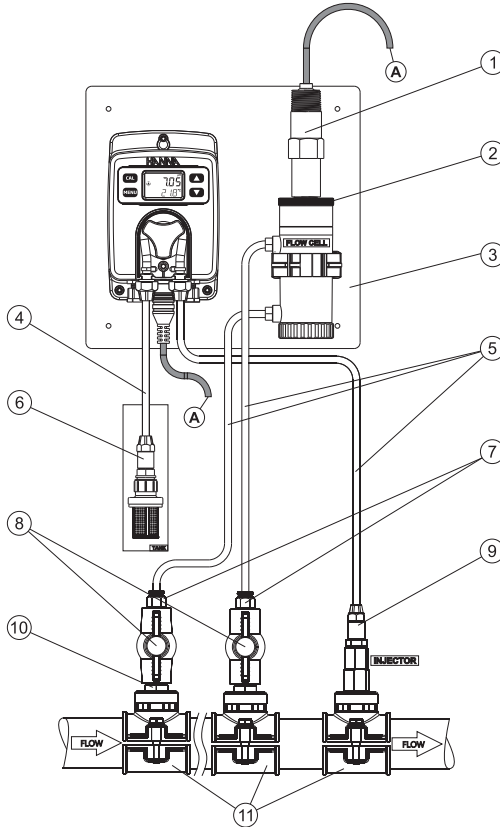

Position	Description
1	Electrode
2	Flow cell and adapter
3	Mounting panel
4	Flexible PVC tubing
5	Rigid PE tubing
6	Aspiration filter
7	1/2" to 6mm adapter for tubing
8	Valve to control flow cell flow
9	Injector, 1/2" thread
10	Nipple, 1/2" - 1/2"
11	Saddle for Ø 50 mm pipe, using 1/2" thread

Mounting Recommendations for Saddle

- Select required drill size. See table for dimension details.

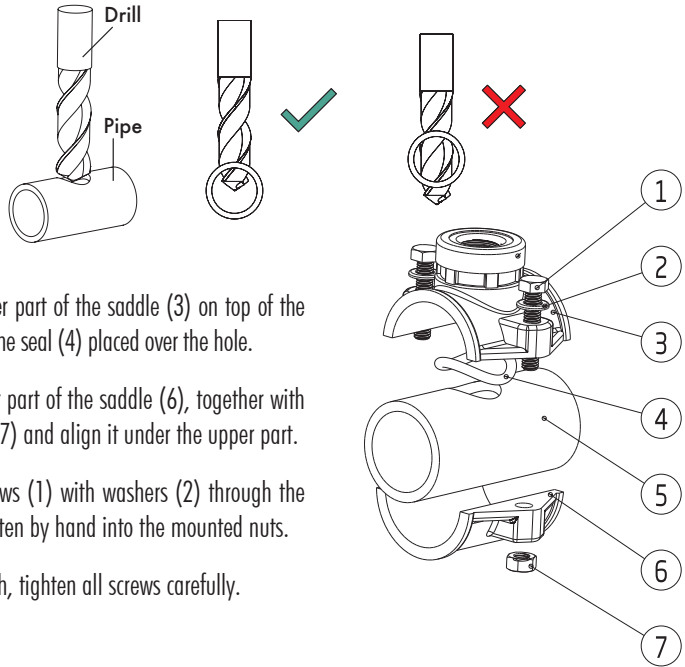

- Place the upper part of the saddle (3) on top of the pipe (5) with the seal (4) placed over the hole.
- Take the lower part of the saddle (6), together with inserted nuts (7) and align it under the upper part.
- Insert the screws (1) with washers (2) through the holes and tighten by hand into the mounted nuts.
- Using a wrench, tighten all screws carefully.

Saddle for probe & injector	Thread size	Drill size
Ø 50 mm pipe	1/2" thread	20 mm - 25.4 mm / 0.79" - 1.00"
Ø 63 mm pipe	1/2" thread	20 mm - 25.4 mm / 0.79" - 1.00"
Ø 75 mm pipe	1/2" thread	20 mm - 25.4 mm / 0.79" - 1.00"

Connecting the Probe to the Pump Controller (In-line Configuration)

The probe should be connected to the controller and calibrated before installation.

Insert the probe and screw it carefully into the saddle, taking care not to damage the O-ring. Tighten the probe enough to ensure a tight seal.

To avoid twisting the cable, unplug probe from socket temporarily while installing in flow cell or in saddle.

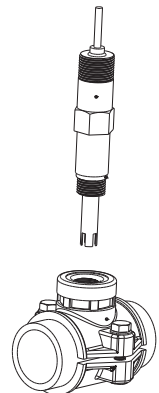

Installing Aspiration Filter

The aspiration filter is used in the reagent tank to filter and prevent debris from entering the tubing.

- Cut required length of aspiration tubing (flexible) to reach between peristaltic pump inlet and aspiration filter.
- Place the end of tubing on the filter.
- The compression fitting has to be screwed until secured on the filter.
- Slide the compression fitting from the peristaltic pump inlet onto the tubing.
- Slide the end of tubing over the fitting of the peristaltic pump tubing.
- Slide compression fitting up over tubing.
- Tighten the fitting.

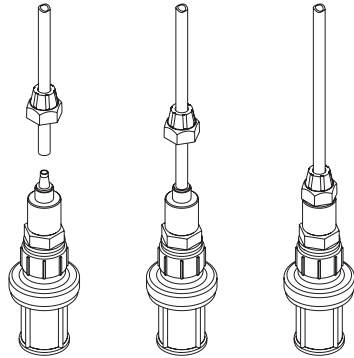

Installing Injector

- Cut the required length of dispensing (rigid) tubing to reach between injector saddle and outlet of peristaltic pump.
- Place the compression fitting nut on the tubing.
- Place the end of tubing on the injector.
- The compression fitting has to be screwed until secured on the injector.
- Screw the injector in the saddle.
- Slide compression fitting from pump tubing onto tubing.
- Slide the end of tubing over fitting of pump tubing.
- Slide compression fitting over tubing.
- Secure and tighten the fitting.

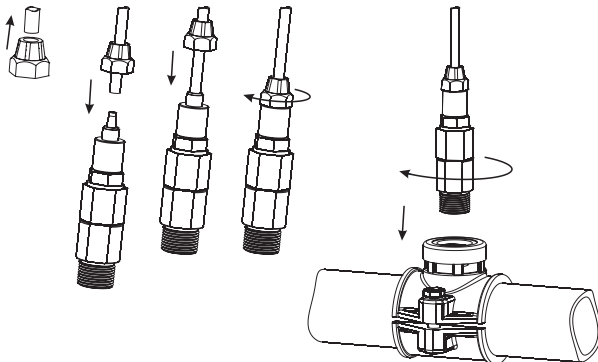

Flow Cell Installation

In a flow cell configuration, the water flows from the inlet valve to the flow cell and returns in the line via the outlet valve.

To prepare the inlet and outlet valve assemblies, as illustrated in the drawing:

- To mount the saddle for flow cell inlet and outlet valve, follow mounting recommendations for saddle.
- Sparingly lubricate two O-rings (2) with a thin film of grease and mount them on the nipple (1) on both sides.
- Screw the nipple in the saddle (3).
- Screw the valve (4) into the open end of the nipple mounted into the saddle. Make sure it is tight and the lever is facing forward so that it can be operated.
- Carefully screw the straight tubing fitting (5) into the valve, taking care not to damage the O-ring.
- Insert the tubing (6) in the straight tubing fitting (5).

Position	Description
1	Nipple
2	O-ring
3	Saddle
4	Valve
5	Tubing fitting
6	Tubing

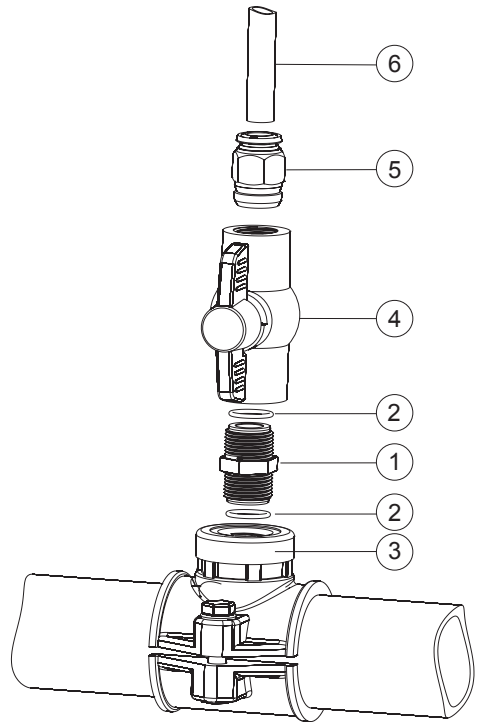

Connecting the Probe to the Pump Controller (Flow Cell Configuration)

- Remove the protective cap and verify if the O-ring (2) is in place.
- Carefully insert the probe (1) into the flow cell adapter (3), paying attention not to damage the O-ring. Tighten the probe enough to seal in place.
- Cut the tubing (7) to reach between the inlet valve mounted on the pipe and the flow cell inlet. Push the end of the tubing (7) into the elbow tubing fitting (4).
- Repeat the previous step for flow cell outlet pushing the tubing (5) into the elbow tubing fitting (4).

Position	Description
1	Probe
2	O-ring
3	Flow cell adapter
4	Elbow tubing fitting
5	Tubing
6	Elbow tubing fitting
7	Tubing

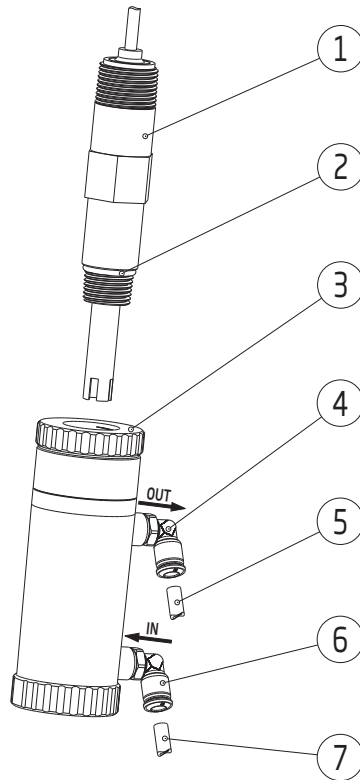

Note: prepare and calibrate the probe prior to installing in the flow cell.

7. SETUP

- Short press MENU key to enter in Setup and to move to next item in menu.
- Long press MENU key to exit.
- Press arrow keys to change the values.
- Short press MENU key to automatically save modified values.

Table below presents an overview of **BL100** menu with ranges and factory set defaults.

Parameter (Scrolled message)	Range / Option	Default settings
Control	Auto or oFF	Auto
Control type	on/oFF or Proportional	on/oFF
Control mode	Hi or Lo	Hi
Set point	6.00 to 8.00	7.20
Hysteresis (on/oFF only)	0.1 to 1.00 pH	0.50
Band (Proportional only)	0.1 to 2.00 pH	1.0
Start up delay (seconds)	0 to 600	60
Overtime alarm (minutes)	oFF, 0 to 180	30
Flow rate (Liter/hour)	0.5 to 3.5	1.0
Flow rate (Gallon/hour)	0.13 to 0.92	0.26
Level alarm	diS or En	diS
High alarm	diS or En	En
High alarm value (pH)	0 to 14.00 pH*	8.00 pH
Low alarm	diS or En	diS
Low alarm value (pH)	0 to 13.90 pH*	6.00 pH
Temperature unit	°C or °F	°C
Flow rate unit	L.H or GAL.H	L.H
Language	En (English), ES (Spanish), Fr (French), Pt (Portuguese), nL (Dutch), dE (German)	En (English)

*Available range changes, based upon other settings.

High alarm must be set higher than low alarm. If low alarm was set 7 pH, then high alarm range is 7.1 to 14 pH.

Table below presents an overview of **BL101** menu with ranges and factory set defaults.

Parameter (Scrolled message)	Range / Option	Default Settings
Control	Auto or oFF	Auto
Control type	on/oFF or Proportional	on/oFF
Control mode	Hi or Lo	Lo
Set point	200 to 900 mV	700 mV
Hysteresis (on/oFF only)	10 to 100 mV	50 mV
Band (Proportional only)	10 to 200 mV	100 mV
Start up delay (seconds)	0 to 600	60
Overtime alarm (minutes)	oFF, 0 to 180	30
Flow rate (Liter/hour)	0.5 to 3.5	1.0
Flow rate (Gallon/hour)	0.13 to 0.92	0.26
Level alarm	diS or En	diS
High alarm	diS or En	diS
High alarm value (mV)	-1990 to 2000 mV*	900 mV
Low alarm	diS or En	En
Low alarm value (mV)	-2000 to 1990 mV*	200 mV
Temperature unit	°C or °F	°C
Flow rate unit	L.H or GAL.H	L.H
Language	En (English), ES (Spanish), Fr (French), Pt (Portuguese), nL (Dutch), dE (German)	En (English)

*Available range changes, based upon other settings.

High alarm must be set higher than low alarm. If low alarm was set 1000 mV, then high alarm range is 1010 to 2000 mV.

Control

Option: Auto or Off (oFF) to enable or disable the control

With disabled option oFF, the control is off.

Press one of the arrow keys for the controller settings to change from Auto to oFF and vice versa.

To run a ten-seconds pump test, long press the arrow keys together until the pump starts to run.

“CONTROL” message is scrolled on the bottom of the LCD screen.



On/Off Control

Press the arrow keys to switch between proportional and on/off control options.

“CONTROL TYPE” message is scrolled on the bottom of the LCD screen.



Note: To enter Control Type screen, pump control mode must be set as Auto.

Proportional Control

Press the arrow keys to switch between proportional and on/off control options.

“CONTROL TYPE” message is scrolled on the bottom of the LCD screen.



Note: To enter Control Type screen, pump control mode must be set as Auto.

Control Mode

Option: Low (Lo) mode or High (Hi) mode

Press the arrow keys to switch between the options.

“CONTROL MODE” message is scrolled on the bottom of the LCD screen.



Note: To enter Control Mode screen, pump control mode must be set as Auto.

Set point

General: a set point is a threshold value that will trigger control if the measurement value crosses it. With a Hi control mode, the measurement approaches the set point from a lower measurement value. With a Lo control mode, the measurement approaches the set point from a higher measurement value than the set point.

Option: user selectable

Press the arrow keys to assign the set point value.

“SET POINT” message is scrolled on the bottom of the LCD screen.



Note: To enter Set point screen, pump control mode must be set as Auto.

Hysteresis / Proportional Band

Hysteresis (On/Off Control only)

On/Off control action turns the dosing on or off based on a previously assigned set point. The pump status (running/not running) changes depending on pH/ORP changes. To prevent oscillation, a pH/ORP band, called hysteresis, is created between the on and off operations.

The pump starts dosing when the measurement crosses the set point value. The pump stops dosing when the measurement crosses the set point value \pm hysteresis band.

Proportion band (Proportional Control only)

The proportional band is a control variable and is defined as the amount of change in input, required to cause the control output to go through 100% of operating range.

Option: user selectable

In order to set the hysteresis value, automatic control must be enabled, with On/Off control type On. Press the arrow keys to set the value.

In order to set the proportional band value, automatic control must be enabled, with Proportional control type on. The pump is continuously on at the set point value with added band.

Press the arrow keys to set the value.

“HYSTERESIS” message is scrolled on the bottom of the LCD screen.



Note: To enter Hysteresis / Band screen, pump control mode must be set as Auto.

Startup Delay (Automatic Control Only)

Option: user selectable

Startup delay represents the delay to start dosing at power-on.

Press the arrow keys to change the time values.

“STARTUP DELAY SEC” message is scrolled on the bottom of the LCD screen.



Note: To enter Startup Delay screen, pump control mode must be set as Auto.

Overtime Alarm

Option: user selectable

Press the arrow keys to change the time values. Overtime alarm range is from 1 to 180 minutes.

To disable the alarm, select Off.

“OVERTIME ALARM MIN” message is scrolled on the bottom of the LCD screen.



Note: To enter Overtime alarm screen, pump control mode must be set as Auto.

Flow Rate

Option: user selectable

Press the arrow keys to change the values.

When in On/Off automatic control mode, the displayed value represents the actual flow rate.

When in Proportional automatic control mode, the displayed value represents a 100% flow rate.

“FLOW RATE L/H” or “FLOW RATE G/H” message is scrolled on the bottom of the LCD screen.



Level Alarm

Option: Enabled (En) or disabled (diS)

Press the arrow keys to switch between the options.

“LEVEL ALARM” message is scrolled on the bottom of the LCD screen.



Note: Option can only be used with properly wired level sensor.

High Alarm

Option: Enabled (En) or disabled (diS)

Press the arrow keys to switch between the options.

“HIGH ALARM” message is scrolled on the bottom of the LCD screen.

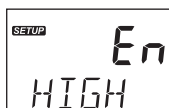

High Alarm Value

Option: user selectable

The range is influenced by the low-alarm value set (e.g. if low-alarm value is set as 5 pH, high-alarm value can be set from 5.10 pH and incremented up to 14.00 pH).

“HIGH ALARM VALUE” message is scrolled on the bottom of the LCD screen.



Note: The user can set the high-alarm value with high-alarm option enabled only.

Low Alarm

Option: Enabled (En) or disabled (diS)

Press the arrow keys to switch between the options.

“LOW ALARM” message is scrolled on the bottom of the LCD screen.

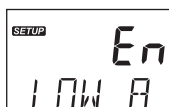
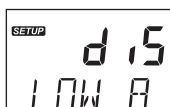

Low Alarm Value

Option: user selectable

The range is influenced by the high-alarm value set (e.g. if high-alarm value is set as 8 pH, low-alarm value can be set from 0.00 pH and incremented up to 7.90 pH).

“LOW ALARM VALUE” message is scrolled on the bottom of the LCD screen.



Note: The user can set the low-alarm value with low-alarm option enabled only.

Temperature Unit

Option: user selectable: °C or °F

Press the arrow keys to change the values.

“TEMPERATURE UNIT” message is scrolled on the bottom of the LCD screen.

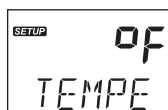
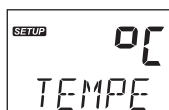

Flow Rate Measurement Unit

Option: Liter/hour (L.H) or Gallon/hour (GAL.H)

Press the arrow keys to switch between the options.

“FLOW RATE UNIT” message is scrolled on the bottom of the LCD screen.



Languages

Option: user selectable

Press the arrow keys to change the language.

“LANGUAGE” message is scrolled on the bottom of the LCD screen.



Note: “LANGUAGE” message, scrolled on the second line, is translated into the selected language.

8. PUMP CONTROL

Pump control can be enabled (automatic control) or disabled (off; manual control). See SETUP section for further details on how to enable or disable pump control.

LCD backlight color indicates the pump control status:

- green - automatic control or in View menu mode
- light green - for manual control or in Edit menu mode

On the LCD screen, the pump status is displayed as below:

manual control is set, no dosing 

ready to dose, dosing 

Startup Delay (Automatic Control Only)

When Startup Delay option is enabled, the meter is in Control Off mode for the set time; and the LCD backlight color is light green. The delay countdown will start upon powering the controller. At the end of the timing the LCD backlight turns green and the control mode is automatic (Auto).



8.1. AUTOMATIC CONTROL TYPES

There are two automatic control types: On/Off (constant) control and proportional control.

On/Off Control

With On/Off control type for pH enabled in SETUP, the algorithm uses only “set point” and “hysteresis”, both with user-selectable values. See SETUP section for further details.

High control mode: When the process pH drifts upward and it reaches a high set point, this triggers the reagent pump to turn on and add an acid to decrease the pH. The pump will remain on until the pH has decreased to the set point value minus the hysteresis value. Then the pump will shut off.

Low Control mode: Conversely, with Low control mode, the process pH drifts down until it reaches a low set point. This triggers the pump to turn on and add a base to increase the pH. The pump will remain on until the pH has increased to the set point value plus the hysteresis value. Then the pump will shut off.

The typical pool application uses a high control point with the addition of an acid.

The BL101 operates in a similar manner with ORP as measurement and chlorine for dosing.

The typical pool application uses a low control point and the addition of chlorine solution to increase the ORP value.

On/Off Control

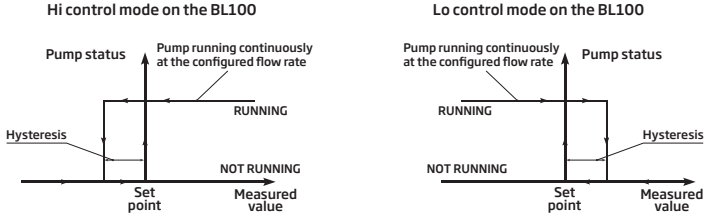

Proportional Control

With Proportional control enabled in SETUP, the dosing time depends on the difference between pH (or ORP) value and assigned setpoint.

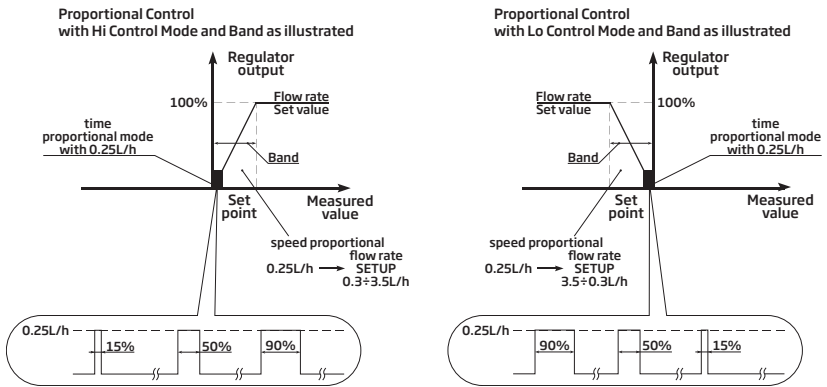

An overview of pH proportional control is presented in the graph below.

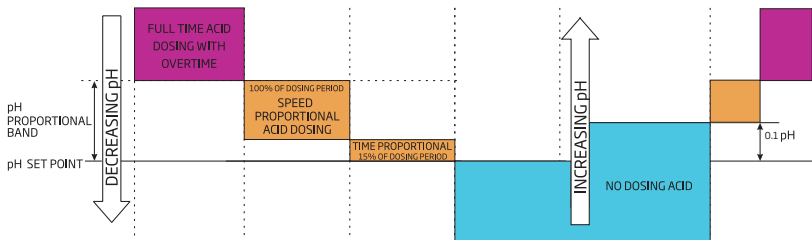

The same principle applies to ORP control.

8.2. MANUAL CONTROL

- From measurement mode, long press the arrow keys together to manually activate the pump.
- To exit from manual control, release the two keys.
- During the manual control, the LCD backlight is light green.





9. EVENTS MANAGEMENT

9.1. ALARMS

Alarms can be independently enabled or disabled in SETUP.



Any event that activates the alarm turns automatic control Off, the alarm relay is deactivated and the LCD backlight is blinking red.

The table below illustrates the conditions that will activate the alarm and deactivate the control pump.





Alarm	Description	Alarm condition	Solution
Overtime alarm	Pump remains on continuously for the time set in menu Overtime Alarm setting	 The LCD display shows a pH reading of 1.30. Below the reading, the text "ALARM CONTROL OFF" is visible. At the bottom of the display, the word "OVERT" is shown in large letters, indicating an overtime alarm.	Control can be switched off. Pump is activated in Manual mode.
Hold level alarm	Low-level sensor active	 The LCD display shows a pH reading of 7.04. Below the reading, the text "ALARM CONTROL OFF" is visible. At the bottom of the display, the words "HOLD LEVEL" are shown in large letters, indicating a hold level alarm.	Refill chemical reagent container.
Low alarm	Measured pH / ORP is lower than the Low Alarm threshold value, for more than 5 seconds	 The LCD display shows a pH reading of 2.00. Below the reading, the text "ALARM CONTROL OFF" is visible. At the bottom of the display, the words "LO ALARM" are shown in large letters, indicating a low alarm.	Increase pH / chlorine content of process to acceptable values.
High alarm	Measured pH / ORP is higher than set threshold alarm High pH, for more than 5 seconds	 The LCD display shows a pH reading of 12.01. Below the reading, the text "ALARM CONTROL OFF" is visible. At the bottom of the display, the words "HI ALARM" are shown in large letters, indicating a high alarm.	Decrease process pH / chlorine content to acceptable values.

9.2. WARNINGS

Two types of warnings can be independently enabled or disabled in SETUP. If any of the warnings is active, the LCD backlight turns light green.

Warnings	Description	Screenshot for warning solution	Solution
Startup delay	Start up delay is active	 	Press the up / down arrows at same time to restart pump. Access pH, ORP, reagent levels to determine why pH or chlorine level is off.
Control Off	Control is switched Off		Set Control setting to Auto

9.3. SUMMARY OF GENERAL BEHAVIOR

Behavior	Control	Backlight	Alarm Output Relay
Control - auto	auto	green 	off
Warning active	off	light green 	off
Error active	off	red 	on
Alarm active	off	red (blinking) 	on

10. CALIBRATION

10.1. pH CALIBRATION (BL100 ONLY)

The pH electrode can be calibrated on the BL100 using an automatic two-point calibration.

The electrode should be calibrated:

- Before in-line or flow cell installation
- Whenever the pH electrode is replaced
- When higher accuracy is required
- After periodic maintenance

Always use fresh calibration buffers and perform electrode maintenance (see ELECTRODE CONDITIONING & MAINTENANCE section) prior to calibration.

Preparation

Pour small quantities of the buffer solutions into clean beakers. If possible, use plastic beakers to minimize any EMC interferences. For accurate calibration and to minimize cross-contamination, use two beakers for each buffer solution: one for rinsing the electrode and one for calibration.

User Calibration

One- or two-point calibration can be performed using one of the three standard buffer solutions: 4.01, 7.01 or 10.01 pH.

When a two-point calibration is required, use 7.01 pH buffer as first calibration point.

Procedure

- Press CAL key to enter calibration mode.
- Place the electrode in chosen pH buffer solution.
- Press CAL key to save calibration point and return to measurement screen.
- Long press MENU key to exit without saving.

One-Point Calibration

- Press CAL key to enter calibration mode. "pH 7.01 USE" message is displayed as first calibration point.
- Place the electrode in 4.01, 7.01 or 10.01 pH buffer. The controller automatically recognizes the buffer value.
- When the buffer is recognized, "RECOGNIZED" is scrolled at the bottom of the LCD display. "WAIT" is displayed until the reading is stable and the calibration is accepted.



- If the buffer is not recognized (either because the pH electrode has not been placed in solution or the reading is outside accepted range), "---- WRONG" message is displayed along with CAL tag blinking.



- After pH 4.01 or 10.01 buffer is accepted, the "SAVE" message is displayed and the controller returns to measurement mode.



- The "CAL" tag is displayed automatically in measurement mode after a calibration has been performed.

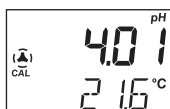

Note: To perform one-point calibration using 7.01 buffer, press CAL key after the buffer is saved.

Two-Point Calibration

- Follow One-Point Calibration section for one-point calibration using pH 7.01. "RECOGNIZED" message is scrolled at the bottom of the LCD until the buffer is recognized.
- After pH 7.01 has been accepted, the "pH 4.01 USE" message is displayed.
- Place the electrode in the second calibration buffer (pH 4.01 or 10.01); it will be automatically recognized. After the second buffer has been accepted, the "SAVE" message is displayed for 1 second and the controller returns to measurement mode.

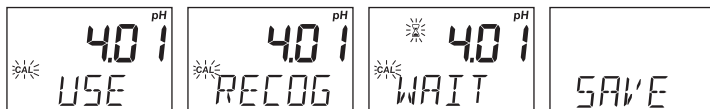

OR



- The "CAL" tag will be displayed in measurement mode after the calibration.



- If the buffer is not recognized, "---- WRONG" message is displayed. It is recommended to change the solution and / or clean the electrode.



- Press CAL key to exit calibration.

Note: If high accuracy is required, a two-point calibration is recommended.

pH Process Calibration

Prior to performing a process calibration, use a calibrated portable pH meter and probe to determine pH of the pool. Write the value down.

Note: To enter process calibration, the user must have the controller and probe calibrated previously on the meter. The "CAL" tag must be on.

pH process calibration is a single point calibration performed while the probe remains installed in the process. The value can be set ± 0.50 pH around measured pH.

- Press CAL key to enter calibration mode. When the first buffer value is displayed, press one of the arrow keys to enter process calibration.



- Press the arrow keys again to adjust the process calibration value to what was determined with the hand held measurement. "PROCESS" message is scrolled on the bottom of the LCD screen.



- Press CAL key to confirm the value (the "SAVE" message appears for a few seconds).
- Press MENU key to exit without saving and return to measurement mode (the "ESC" message is displayed for a few seconds).

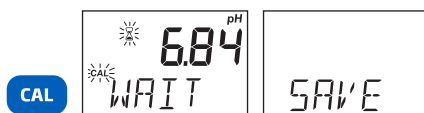

10.2. ORP CALIBRATION (BL101 ONLY)

ORP calibration is a single point process calibration. The value can be set ± 50 mV around measured ORP.

The probe may be calibrated in an ORP standard prior to installation or it may also be calibrated while installed in the process by adjusting the value to that of a calibrated portable meter and probe.

- Place probe tip into beaker of standard.
- Wait for it to equilibrate.
- Follow the ORP process directions below to calibrate the probe and controller.
- Wash with purified water before handling and installing into pool control piping.
- Dispose of standard safely.

ORP Process Calibration

- Press CAL key to enter calibration mode.



- Press the arrow keys to adjust the process calibration value to the value determined with a hand held meter and probe. "PROCESS" message is scrolled on the bottom of the LCD screen.

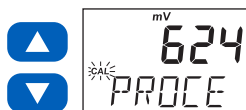

- Press CAL key to confirm the value (the "SAVE" message is displayed for a few seconds).
- Press MENU key to exit without saving and return to measurement mode (the "ESC" message appears for a few seconds).

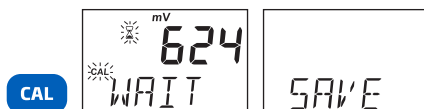

10.3. pH & ORP CLEAR CALIBRATION

- Press CAL key and the controller enters calibration mode.

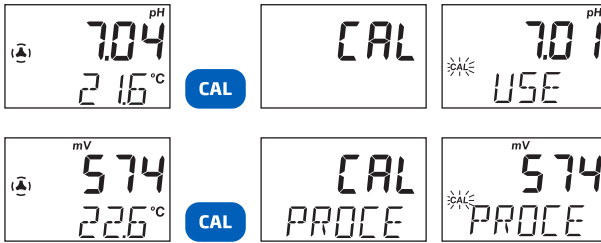

- Long press MENU key and the "CLEAR" message is displayed.
- The "CAL" tag is not displayed in measurement mode, indicating no calibration (until a new calibration is performed.)

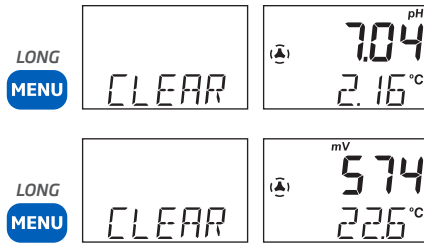

11. MEASUREMENT

- Power the controller. All LCD segments will be displayed for a few seconds. After initialization has been completed, the controller displays the measurement screen.
- Plug the probe into the dedicated socket. Use the key to install properly.
- The pH / ORP electrode is automatically recognized. If the wrong probe is used, the meter will indicate an error.
- After setting up the controller menu, probe and all required accessories, the controller is ready for measurement.
- From measurement mode, press both arrow keys simultaneously to prime the pump and to verify the flow cell fills correctly (if used).
- If power is lost, then restored, the controller keeps the last used control mode (enabled / automatic, disabled / manual) and LCD backlighting signals the state of the pump and measurement (green backlight for automatic control, light green for manual control, red for alarms or errors).

BL100, control enabled

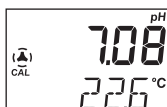

BL101, control disabled

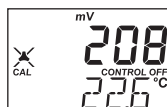

First LCD line displays measured pH / ORP value, the second LCD line displays the temperature. If a calibration was performed, the screen displays the CAL tag.

Measurements are updated every second and conditions are updated automatically. The pump starts or stops depending on configured settings (control mode and type, set point, hysteresis or proportional band, start-up delay timer, overtime time alarms).

12. ERROR MESSAGES

The pump controller shows clear error messages when erroneous conditions appear and when measured values are outside the expected range.

The information below provides an explanation of the errors, and recommended action to be taken. Error messages are displayed with red LED backlight.



Probe is not connected.
Connect the probe.

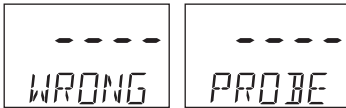

Wrong probe is connected.
Unplug the controller and ensure correct probe will be plugged in.

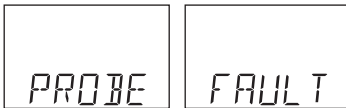

Broken temperature sensor.
Replace the probe.



The temperature is out of range (BL100).



The pH (BL100) or the ORP (BL101) measured value is out of range.



Stepper motor error: over temperature or overcurrent is detected.
When the error has ceased, the stepper motor resumes normal function.

13. MAINTENANCE

13.1. ELECTRODE CONDITIONING & MAINTENANCE

Preparation

- Remove the electrode protective cap. Do not be alarmed if any salt deposits are present, this is normal. Rinse the probe with water.
- Shake the electrode down as you would do with a clinical thermometer to eliminate any air bubbles inside the glass bulb (pH electrode only).
- If the bulb and/or junction are dry, soak the electrode in [HI70300](#) storage solution for a minimum of 30 minutes. Rinse with water.
- Calibrate before using.
- When the electrode is not in use, add a few drops of [HI70300](#) storage solution to the protective cap and replace the cap. To ensure a quick response, the glass bulb (pH electrode) and the junction should be kept moist and not allowed to dry out. This can be achieved by installing the probe in such a way that it is constantly in the filled flow cell or the pipe filled with the sample.

Note: Never store the electrode in distilled or deionized water.

13.2. PUMP TUBING REPLACEMENT

For pump tubing replacement please wear protective gloves and eye protection at all times; and follow the steps below:

1. Power off the controller.
2. Disconnect the tubing from the pump.
3. Remove the plastic cover from the pumps, which is fixed with a screw.

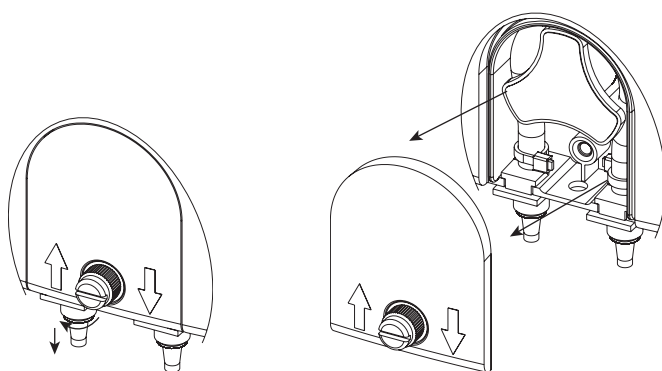

- Starting from the left side of the pump, grab the tubing and rotate the pump manually to the right, until the tubing is removed.

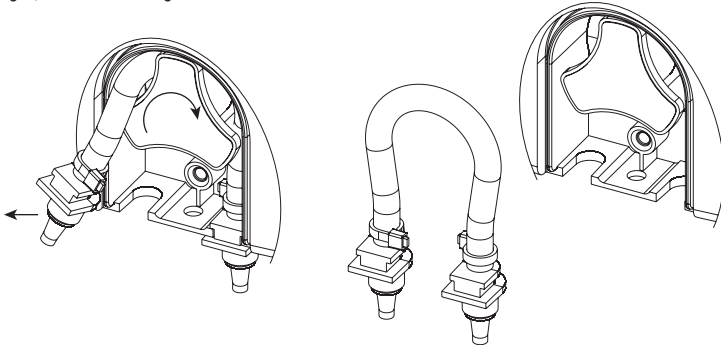

- Grease the new tubing and place it on the left side of the pump, inserting the tube holder in place. Manually rotate the pump to the right until the tubing is on the pump.
- Fix the plastic holder in its place on the right side.

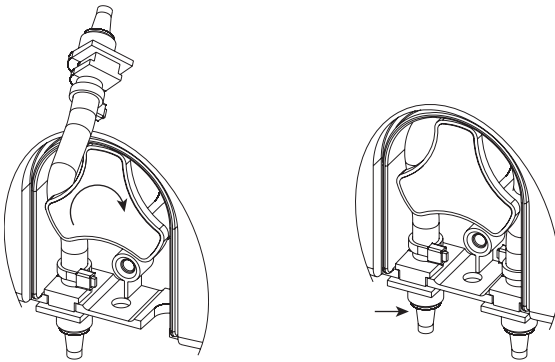

- Place the plastic cover. Reattach the tubing to the pumps. Slide the compression fitting along the tubing and tighten fitting on threads.

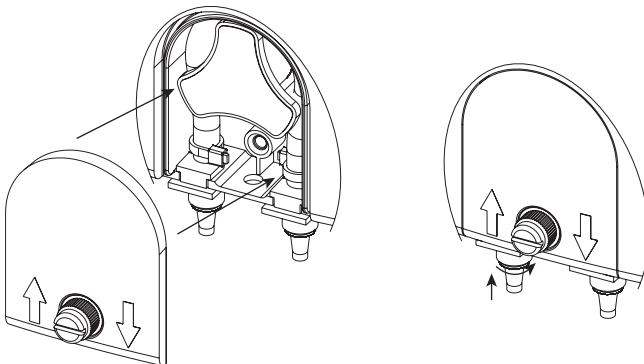

14. ACCESSORIES

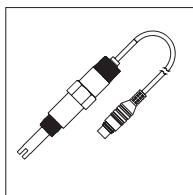

HI10053 pH/temp. probe with 2 m cable, DIN Quick connect

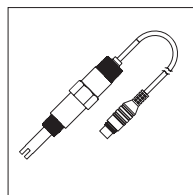

HI20083 ORP/temp. probe with 2 m cable, DIN Quick connect

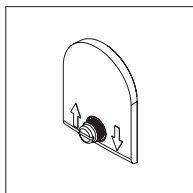

BL100-302 Pump cover with screw

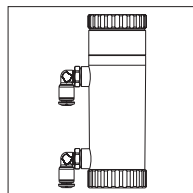

BL100-410 Flow cell for BL100/BL101

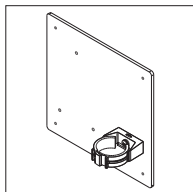

BL100-411 Flow cell panel

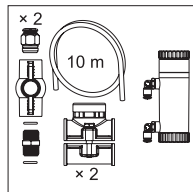

BL100-450 Flow cell kit for Ø 50 mm pipe

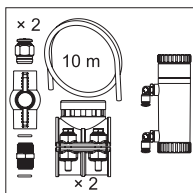

BL100-463 Flow cell kit for Ø 63 mm pipe

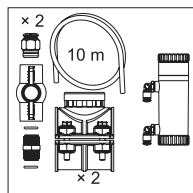

BL100-475 Flow cell kit for Ø 75 mm pipe

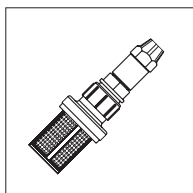

BL120-200 Pool controller aspiration filter

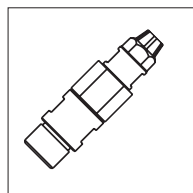

BL120-201 Pool controller injector, 1/2" thread

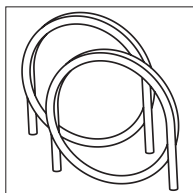

BL120-202 Aspiration and dispensing tubing (5 + 5 m)

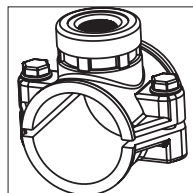

BL120-250 Injector saddle for Ø 50 mm pipe, 1/2" thread

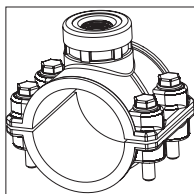

BL120-263
Injector saddle for
Ø 63 mm pipe,
1/2" thread

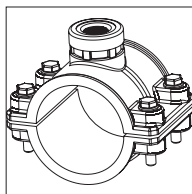

BL120-275
Injector saddle for
Ø 75 mm pipe,
1/2" thread

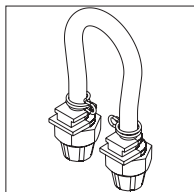

BL120-300
Peristaltic pump
tubing kit

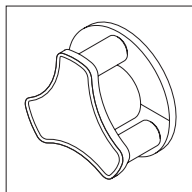

BL120-301
Peristaltic pump
rotor

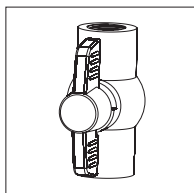

BL120-401
Flow cell valve

Other Accessories

HI70004P	pH 4.01 buffer sachet, 20 mL (25 pcs.)
HI70007P	pH 7.01 buffer sachet, 20 mL (25 pcs.)
HI70010P	pH 10.01 buffer sachet, 20 mL (25 pcs.)
HI70022P	ORP test solution, 470 mV @ 25 °C, 20 mL (25 pcs.)
HI7004L	pH 4.01 buffer solution, 500 mL
HI7007L	pH 7.01 buffer solution, 500 mL
HI7010L	pH 10.01 buffer solution, 500 mL
HI7021L	ORP test solution, 240 mV @ 25 °C, 500 mL
HI7022L	ORP test solution, 470 mV @ 25 °C, 500 mL
HI70300L	Storage solution, 500 mL
HI7091L	Reducing pretreatment solution
HI7092L	Oxidizing pretreatment solution, 500 mL
HI7061L	General cleaning solution, 500 mL
HI740036P	Plastic beaker set, 100 mL (10 pcs.)

CERTIFICATION

All Hanna Instruments conform to the **CE European Directives**.



Disposal of Electrical & Electronic Equipment. The product should not be treated as household waste. Instead hand it over to the appropriate collection point for the recycling of electrical and electronic equipment which will conserve natural resources. Ensuring proper product disposal prevents potential negative consequences for the environment and human health. For more information, contact your city, your local household waste disposal service, the place of purchase or go to www.hannainst.com.



RECOMMENDATIONS FOR USERS

Before using this product, make sure it is entirely suitable for your specific application and for the environment in which it is used. Any variation introduced by the user to the supplied equipment may degrade the controller's performance. For yours and the controller's safety do not use or store the controller in hazardous environments.

WARRANTY

The **BL100** & **BL101** are warranted for two years (probes for six months) against defects in workmanship and materials when used for its intended purpose and maintained according to instructions. This warranty is limited to repair or replacement free of charge. Damage due to accidents, misuse, tampering or lack of prescribed maintenance is not covered.

If service is required, contact your local Hanna Instruments Office. If under warranty, report the model number, date of purchase, serial number (engraved on the bottom of the meter) and the nature of the problem. If the repair is not covered by the warranty, you will be notified of the charges incurred. If the instrument is to be returned to Hanna Instruments, first obtain a Returned Goods Authorization (RGA) number from the Technical Service department and then send it with shipping costs prepaid. When shipping any instrument, make sure it is properly packed for complete protection.

Hanna Instruments reserves the right to modify the design, construction or appearance of its products without advance notice.

World Headquarters

Hanna Instruments Inc.
Highland Industrial Park
584 Park East Drive
Woonsocket, RI 02895 USA
www.hannainst.com



MANBL10X

Printed in ROMANIA